

DVD PLAYER

DVD-S510/DV-S5350

SERVICE MANUAL

IMPORTANT NOTICE

This manual has been provided for the use of authorized YAMAHA Retailers and their service personnel. It has been assumed that basic service procedures inherent to the industry, and more specifically YAMAHA Products, are already known and understood by the users, and have therefore not been restated.

WARNING: Failure to follow appropriate service and safety procedures when servicing this product may result in personal injury, destruction of expensive components, and failure of the product to perform as specified. For these reasons, we advise all YAMAHA product owners that any service required should be performed by an authorized YAMAHA Retailer or the appointed service representative.

IMPORTANT: The presentation or sale of this manual to any individual or firm does not constitute authorization, certification or recognition of any applicable technical capabilities, or establish a principle-agent relationship of any form.

The data provided is believed to be accurate and applicable to the unit(s) indicated on the cover. The research, engineering, and service departments of YAMAHA are continually striving to improve YAMAHA products. Modifications are, therefore, inevitable and specifications are subject to change without notice or obligation to retrofit. Should any discrepancy appear to exist, please contact the distributor's Service Division.

WARNING: Static discharges can destroy expensive components. Discharge any static electricity your body may have accumulated by grounding yourself to the ground buss in the unit (heavy gauge black wires connect to this buss).

IMPORTANT: Turn the unit OFF during disassembly and part replacement. Recheck all work before you apply power to the unit.

■ CONTENTS

TO SERVICE PERSONNEL	1	INTERACTIVE TESTS	11~17
WARNINGS	1~2	TEST INSTRUCTIONS DISPLAY BOARD	18~19
PREVENTION OF ELECTROSTATIC DISCHARGE	3	TROUBLESHOOTING	20~25
LOCALE MANAGEMENT INFORMATION	3	TECHNICAL SPECIFICATIONS DVD MODULE	26~27
FRONT PANELS	4	LIST OF ABBREVIATIONS	28
REMOTE CONTROL TRANSMITTER	4	IC DESCRIPTIONS	29~39
REAR PANELS	5	WIRING DIAGRAM	40~41
SPECIFICATIONS	6	BLOCK DIAGRAM	42~45
DISASSEMBLY PROCEDURES	7~8	PRINTED CIRCUIT BOARD	46~66
SERVICE HINTS	8	SCHEMATIC DIAGRAM	67~95
DIAGNOSTIC SOFTWARE	9~10	PARTS LIST	96~107



このサービスマニュアルは、エコマーク認定の再生紙を使用しています。
This Service Manual uses recycled paper.



■ TO SERVICE PERSONNEL

1. Critical Components Information

Components having special characteristics are marked  and must be replaced with parts having specifications equal to those originally installed.

2. Leakage Current Measurement (For 120V Models Only)

When service has been completed, it is imperative to verify that all exposed conductive surfaces are properly insulated from supply circuits.

- Meter impedance should be equivalent to 1500 ohm shunted by 0.15 μ F.
- Leakage current must not exceed 0.5mA.
- Be sure to test for leakage with the AC plug in both polarities.

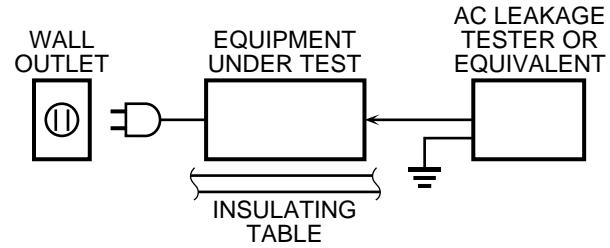

CAUTION: USE OF CONTROLS OR ADJUSTMENTS OR PERFORMANCE OF PROCEDURES OTHER THAN THOSE SPECIFIED HEREIN MAY RESULT IN HAZARDOUS RADIATION EXPOSURE.

THE DVD-VIDEO PLAYER SHOULD NOT BE ADJUSTED OR REPAIRED BY ANYONE EXCEPT PROPERLY QUALIFIED SERVICE PERSONNEL.

■ WARNINGS

WARNING: CHEMICAL CONTENT NOTICE!

The solder used in the production of this product contains LEAD. In addition, other electrical/electronic and /or plastic (where applicable) components may also contain traces of chemicals found by the California Health and Welfare Agency (and possibly other entities) to cause cancer and/or birth defects or other reproductive harm.

DO NOT PLACE SOLDER, ELECTRICAL/ELECTRONIC OR PLASTIC COMPONENTS IN YOUR MOUTH FOR ANY REASON WHATSOEVER!

Avoid prolonged, unprotected contact between solder and your skin! When soldering, do not inhale solder fumes or expose eyes to solder/flux vapor!

If you come in contact with solder or components located inside the enclosure of this product, wash your hands before handling food.

WARNING: Laser Safety

This product contains a laser beam component. This component may emit invisible, as well as visible radiation, which may cause eye damage. To protect your eyes and skin from laser radiation, the following precautions must be used during servicing of the unit.

- 1) When testing and/or repairing any component within the product, keep your eyes and skin more than 30 cm away from the laser pick-up unit at all times. Do not stare the laser beam at any time.
- 2) Do not attempt readjustment, disassemble or repair of the laser pick-up, unless noted elsewhere in this manual.
- 3) CAUTION: Use of controls, adjustments or performance of procedures other than those specified herein may result in hazardous radiation exposure.

Laser Emitting conditions:

- 1) When the Top Cover is removed, and the POWER SW is turned to the "ON" position, the laser component will emit a beam for several seconds to detect if a disc is present. During this time (5 - 10 sec.) the laser may radiate through the lens of the laser pick-up unit. Do not attempt any servicing during this period!
If no disc is detected, the laser will stop emitting the beam. when a disc is set, you will not be exposed to any laser emissions.
- 2) The laser power level can be adjusted with the VR on pick-up PWB, however, this level has been set by the factory prior to shipping from the factory. Do not adjust this laser level control unless instruction is provided elsewhere in this manual. Adjustment of this control can increase the laser emission level from the device.

Laser Diode Properties

Type: Semiconductor laser GaAlAs
 Wave length: 650 nm (DVD)
 780 nm (VCD/CD)
 Output Power: 7 mW (DVD)
 10 mW (VCD/CD)
 Beam divergence: 60 degree

Output value is determined by CFR CHAPTER1, SUBCHAPTER J

VARO! : AVATTAESSA JA SUOJALUKITUS OHITETTAESSA OLET ALTTIINA NÄKYMÄTTÖMÄLLE LASER-SÄTEILYLLE. ÄLÄ KATSO SÄTEESEEN.

WARNING! : OSYNLIG LASERSTRÅLNING NÄR DENNA DEL ÄR ÖPPNAD OCH SPÄRREN ÄR URKOPPLAD. BETRAKTA EJ STRÅLEN.

WARNING

The use of optical instruments with this product will increase eye hazard.
 Repair handling should take place as much as possible with a disc loaded inside the player

U, C models

DANGER - Visible and invisible laser radiation when open. Avoid direct exposure to beam.

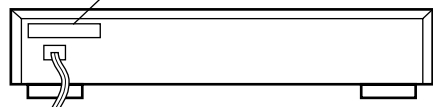

R, A, T models

CAUTION - Visible and invisible laser radiation when open. Avoid exposure to beam.

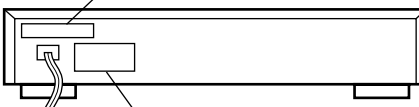

CLASS 1 LASER PRODUCT
 LASER KLASSE 1 PRODUKT
 LUOKAN 1 LASERLAITE
 KLASS 1 LASER APPART

B, G models

CAUTION - Visible and invisible laser radiation when open. Avoid exposure to beam.

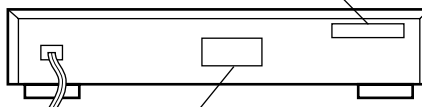

CLASS 1 LASER PRODUCT
 LASER KLASSE 1 PRODUKT
 LUOKAN 1 LASERLAITE
 KLASS 1 LASER APPART

WARNING LOCATION: REAR PANEL

CAUTION VISIBLE AND INVISIBLE LASER RADIATION WHEN OPEN. AVOID EXPOSURE TO BEAM
ADVARSEL SYNLIG OG USYNLIG LASERSTRÅLING VED ÅBNING UNDGÅ UDSÆTTELSE FOR STRÅLING
ADVARSEL SYNLIG OG USYNLIG LASERSTRÅLING NÄR DEKSEL ÅPNES UNNGÅ EKSPONERING FOR STRÅLEN
WARNING SYNLIG OCH OSYNLIG LASERSTRÅLNING NÄR DENNA DEL ÄR ÖPPNAD BETRAKTA EJ STRÅLEN
VARO! AVATT AESSA OLET ALTTIINA NÄKYVÄLLE JA NÄKYMÄTTÖMÄLLE LASER SÄTEILYLLE. ÄLÄ KATSO SÄTEESEEN
VORSICHT SICHTBARE UND UNSICHTBARE LASERSTRAHLUNG WENN ABDECKUNG GEÖFFNET NICHT DEM STRAHL AUSSETZEN
DANGER VISIBLE AND INVISIBLE LASER RADIATION WHEN OPEN. AVOID DIRECT EXPOSURE TO BEAM
ATTENTION RAYONNEMENT LASER VISIBLE ET INVISIBLE EN CAS D'OUVERTURE EXPOSITION DANGEREUSE AU FAISCEAU

Warning for power supply

The primary side of the power supply including the heatsink carries live mains voltage when the player is connected to the mains even when the player is switched off !

This primary area is not shielded so it is possible to touch copper tracks and/or components when servicing the player. Service personnel have to take precautions to prevent touching this area or components in this area .

The primary side of the power supply has been indicated with a lightning stroke and a stripe-marked print on the printed wiring board

Note:

The screws on the DVD mechanism (position 18-1 in on the exploded view drawing) may never be touched, removed or re-adjusted.

Handle the DVD mechanism with care when the unit has to be exchanged!

The DVD mechanism is very sensitive for dropping or giving shocks.

■ PREVENTION OF ELECTROSTATIC DISCHARGE

Some semiconductor (solid state) devices can be damaged easily by static electricity. Such components commonly are called Electrostatically Sensitive (ES) Devices. Examples of typical ES devices are integrated circuits and some field-effect transistors and semiconductor “chip” components. The following techniques should be used to help reduce the incidence of component damage caused by electro static discharge (ESD).

1. Immediately before handling any semiconductor component or semiconductor-equipped assembly, drain off any ESD on your body by touching a known earth ground. Alternatively, obtain and wear a commercially available discharging ESD wrist strap, which should be removed for potential shock reasons prior to applying power to the unit under test.
2. After removing an electrical assembly equipped with ES devices, place the assembly on a conductive surface such as aluminum foil, to prevent electrostatic charge buildup or exposure of the assembly.
3. Use only a grounded-tip soldering iron to solder or unsolder ES devices.
4. Use only an anti-static solder removal device. Some solder removal devices not classified as “anti-static (ESD protected)” can generate electrical charge sufficient to damage ES devices.
5. Do not use freon-propelled chemicals. These can generate electrical charges sufficient to damage ES devices.
6. Do not remove a replacement ES device from its protective package until immediately before you are ready to install it. (Most replacement ES devices are packaged with leads electrically shorted together by conductive foam, aluminum foil or comparable conductive material).
7. Immediately before removing the protective material from the leads of a replacement ES device, touch the protective material to the chassis or circuit assembly into which the device will be installed.
CAUTION: Be sure no power is applied to the chassis or circuit, and observe all other safety precautions.
8. Minimize bodily motions when handling unpackaged replacement ES devices. (Otherwise harmless motion such as the brushing together of your clothes fabric or the lifting of your foot from a carpeted floor can generate static electricity (ESD) sufficient to damage an ES device).

HANDLING PRECAUTIONS

The laser diode in the optical pickup may break down due to potential difference caused by static electricity of clothes or human body. So be careful of electrostatic breakdown during repair of the DVD mechanism.

Grounding for electrostatic breakdown prevention

1. Human body grounding.
Use the antistatic wrist strap to discharge the static electricity from your body.
2. Work table grounding.
Put a conductive material (sheet) or steel sheet on the area where the optical pickup is placed and ground the sheet.

Caution:

The static electricity of your clothes will not be grounded through the wrist strap. So take care not to let your clothes touch the optical pickup.

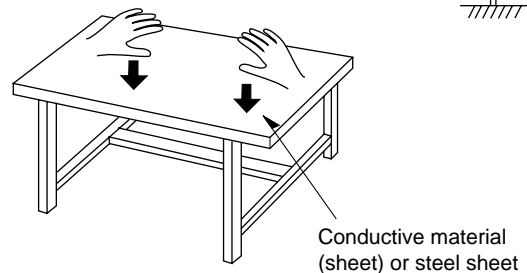
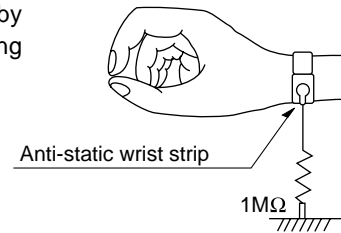

■ LOCALE MANAGEMENT INFORMATION

Locale Management Information : This DVD player is designed and manufactured to respond to the Locale Management Information that is recorded on a DVD disc. If the Locale number described on the DVD disc does not correspond to the Locale number of this DVD player, this DVD player cannot play this disc.

This product incorporates copyright protection technology that is protected by method claims of certain U.S. patents and other intellectual property rights owned by Macrovision Corporation and other rights owners. Use of this copyright protection technology must be authorized by Macrovision Corporation, and is intended for home and other limited viewing uses only unless otherwise authorized by Macrovision Corporation. Reverse engineering or disassembly is prohibited.

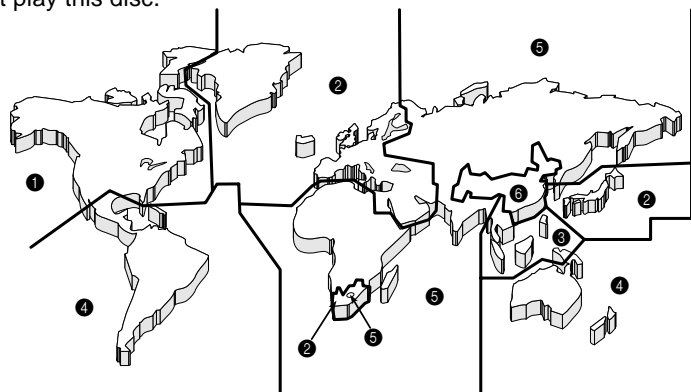

FRONT PANELS

DVD-S510



DV-S5350

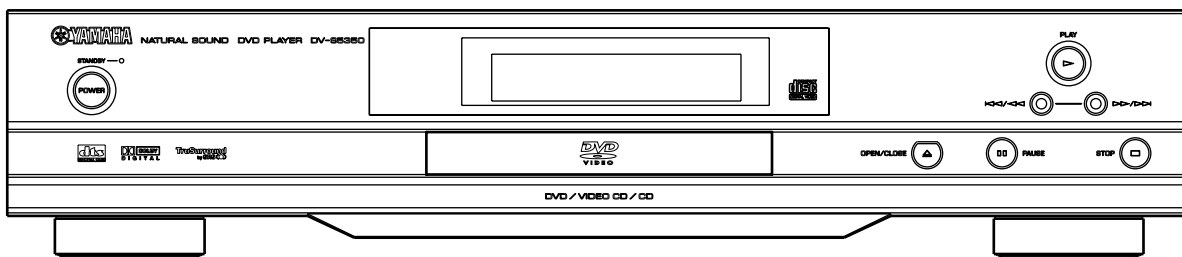

REMOTE CONTROL TRANSMITTER

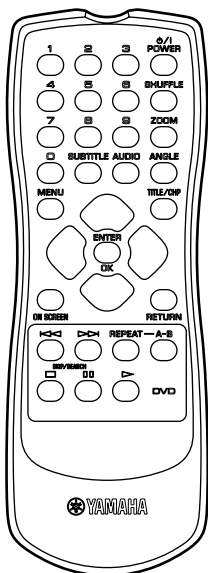

REAR PANELS

DVD-S510 U, C models

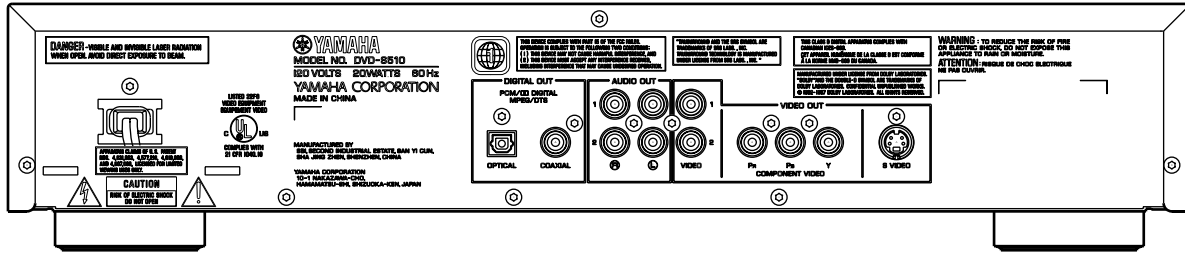

DVD-S510 A model

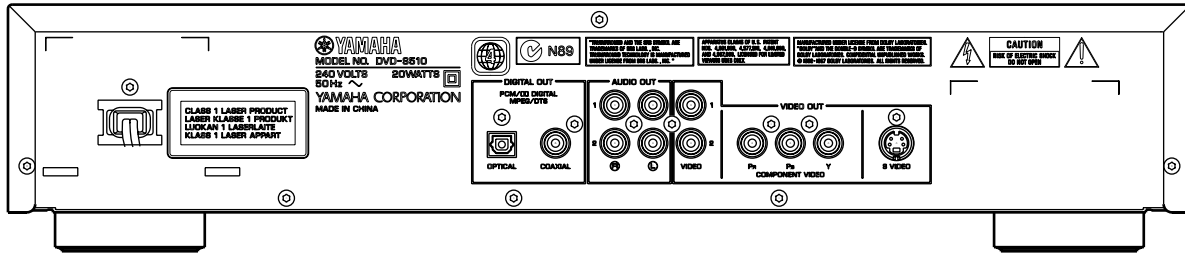

DVD-S510 B, G models

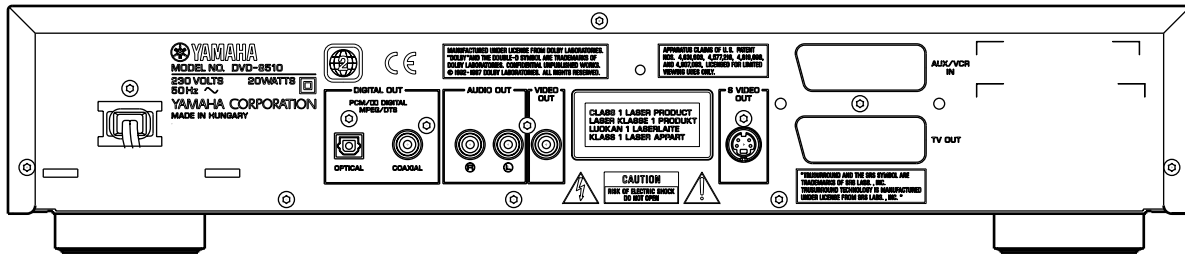

DVD-S510 R model

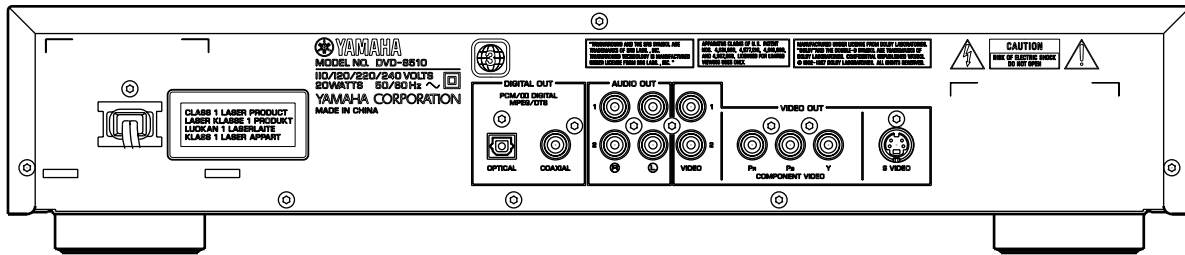

DVD-S510 T model

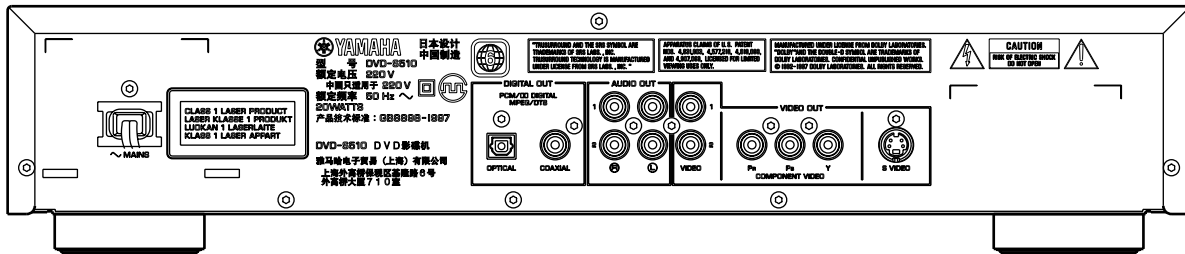

DV-S5350 U model

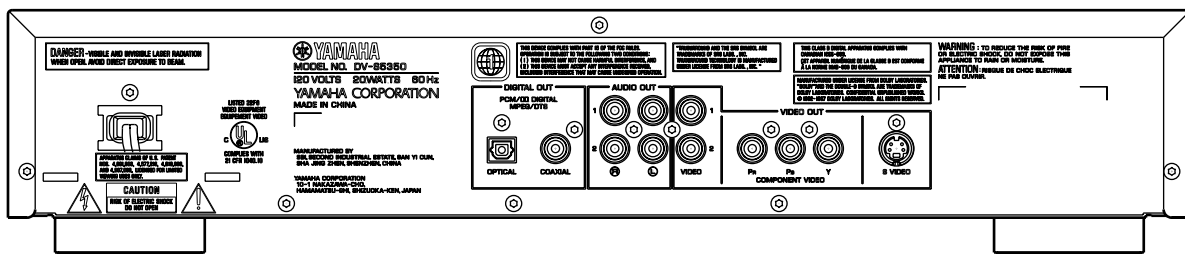

■ SPECIFICATIONS

PLAYBACK SYSTEM

DVD-Video
Video CD
CD (CD-R and CD-RW)

OPTICAL READOUT SYSTEM

Laser type Semiconductor AlGaAs
Numerical Aperture 0.60 (DVD)
0.45 (VCD/CD)
Wavelength 650 nm (DVD)
780 nm (VCD/CD)

DVD DISC FORMAT

Medium Optical Disc
Diameter 12cm (8cm)
Playing time 2.15 h*
(12cm) Dual layer 4 h*
Two side 4.30 h*
Single layer
Two side 8 h*
Dual layer

TV STANDARD

	EUROPE	USA
Number of lines	(PAL/50Hz) 625	(NTSC/60Hz) 525
Playback	Multistandard	(PAL/NTSC)

VIDEO FORMAT

DA Converter 10 bits
Signal handling Components
Digital Compression MPEG2 for DVD,
MPEG1 for VCD

DVD

Horiz. Resolution	720 pixels**	720 pixels**
Vertical Resolution	576 lines	480 lines

VCD

Horiz. Resolution	352 pixels	352 pixels
Vertical Resolution	288 lines	240 lines

VIDEO PERFORMANCE

Video output 1 Vpp into 75 ohm
S-Video output Y: 1 Vpp into 75 ohm
C: 0.3 Vpp into 75 ohm
Y 1 Vpp into 75 ohm (U, C, A, R, T)
CR 0.7 Vpp into 75 ohm (U, C, A, R, T)
CB 0.7 Vpp into 75 ohm (U, C, A, R, T)
RGB output 1 Vpp into 75 ohm (B, G)
Black Level Shift On/Off
Video Shift Left/Right

AUDIO FORMAT

Digital	MPEG	Compressed Digital
	DTS	Compressed Digital
	AC-3	Compressed Digital
	PCM	
Analog	Analog Sound Stereo	
	Dolby Pro Logic downmix from AC-3 multi-channel sound	
	3D Sound for virtual 5.1 channel sound on 2 speakers	

AUDIO PERFORMANCE

DA Converter	24 bits	
DVD	fs 48 kHz	2 Hz - 22 kHz
Video CD	fs 44.1 kHz	2 Hz - 20 kHz
CD	fs 44.1 kHz	2 Hz - 20 kHz
Signal-Noise (1kHz)		95 dB
Dynamic Range (1kHz)		95 dB
Harmonic Distortion + Noise (1kHz)		0.0035 %

CONNECTIONS

SCART	SCART2x (B, G)	
S-Video Output	Mini DIN, 4 pins	
Component Video (U, C, A, R, T)	Y	Cinch (green)
	PB	Cinch (blue)
	PR	Cinch (red)

Video Output	Cinch (yellow) (B, G)
Video Output	Cinch (yellow) x2 (U, C, A, R, T)
Audio L+R output	Cinch (white/red) (B, G)
Audio L+R output	Cinch (white/red) x2 (U, C, A, R, T)
Digital Output	1 coaxial, 1 optical
	IEC958 for CDDA / LPCM
	IEC1937 for MPEG1/2, AC-3 and DTS

GENERAL

Dimensions(w x h x d)	435 x 91 x 314 mm
Weight	Approx. 3.3 Kg
Finish	Black color (U, C, A, B, G)
	Gold color (R, G, T)
	Titan color (G)
Power supply	120 V, 60 Hz (U)
	230 V, 50 Hz (B, G)
	240 V, 50 Hz (A)
	110/120/220/240 V, 50/60 Hz (R)
	220 V, 50 Hz (T)
Power consumption	20 W
Standby mode	5 W (B, G)
	3 W (When low power Standby is on)

PACKAGE CONTENTS

DVD-Video Player, Remote Control & Batteries,
AC Power cord, Owner's Manual, Audio/Video cable (U, C, A, R, T),
Audio cable (B, G), Video cable (B, G)

GENERAL FUNCTIONALITY

Stop / Play / Pause
Fast Forward / Backward
Time search
Step Forward / Backward
Slow
Title / Chapter / Track Select
Skip Next / Skip Previous
Repeat (Chapter / Title / All) or (Track / All)
A-B Repeat
Shuffle
Enhanced ease of use graphical interface
Zoom (x1.33, x2, x4) with picture enhancement
3D Sound
Audio and video bit rate indicator

DVD FUNCTIONALITY

Multi-angle Selection
Audio Selection (1 out of max. 8 languages)
Subtitles Selection (1 out of max. 32 languages)
Aspect Ratio conversion (16:9, 4:3 Letterbox, 4:3 Pan Scan)
Parental Control and DISC Lock
Disc Menu support (Title Menu and Root Menu)
Resume (5 discs) after stop / standby
Screen Saver (Dim 75% after 15 min.)
Programming Titles/chapters with Favorite Selection

VIDEO CD FUNCTIONALITY

Playback Control for VCD 2.0 discs
Parental Control and DISC lock
Resume (5 discs) after stop / standby
Screen Saver (Dim 75% after 15 min.)
Programming Tracks with Favorite Selection

AUDIO CD FUNCTIONALITY

Time Display (Total / Track / Remaining Track Time)
Full audio functionality with remote control
Programming with Favorite Track Selection

* typical playing time for movie with 2 spoken languages and 3 subtitle languages.

** equivalent to 500 lines on your TV

Specifications subject to change without prior notice.

U	U.S.A. model	C	Canada model
G	Europe model	B	British model
A	Australia model	R	General model
T	China model		

TruSurround and the SRS symbol are trademarks of SRS Labs., Inc. TruSurround technology is manufactured under license from SRS Labs., Inc.



Manufactured under license from Dolby Laboratories. "Dolby" and the double-D symbol are trademarks of Dolby Laboratories. Confidential Unpublished Works. ©1992 – 1997 Dolby Laboratories, Inc. All rights reserved.

This product incorporates copyright protection technology that is protected by method claims of certain U. S. patents and other intellectual property rights owned by Macrovision Corporation and other rights owners. Use of this copyright protection technology must be authorized by Macrovision Corporation, and is intended for home and other limited viewing uses only, unless otherwise authorized by Macrovision Corporation. Reverse engineering or disassembly is prohibited.

* Manufactured under license from Digital Theater Systems, Inc. US Pat. No. 5,451,942 and other world-wide patents issued and pending. "DTS", "DTS Digital Surround", are trademarks of Digital Theater Systems, Inc. copyright 1996 Digital Theater Systems, inc. All rights reserved.

DISASSEMBLY PROCEDURES

See exploded view for item numbers.

When disassembling, use the special screw driver with tip shape in figure.

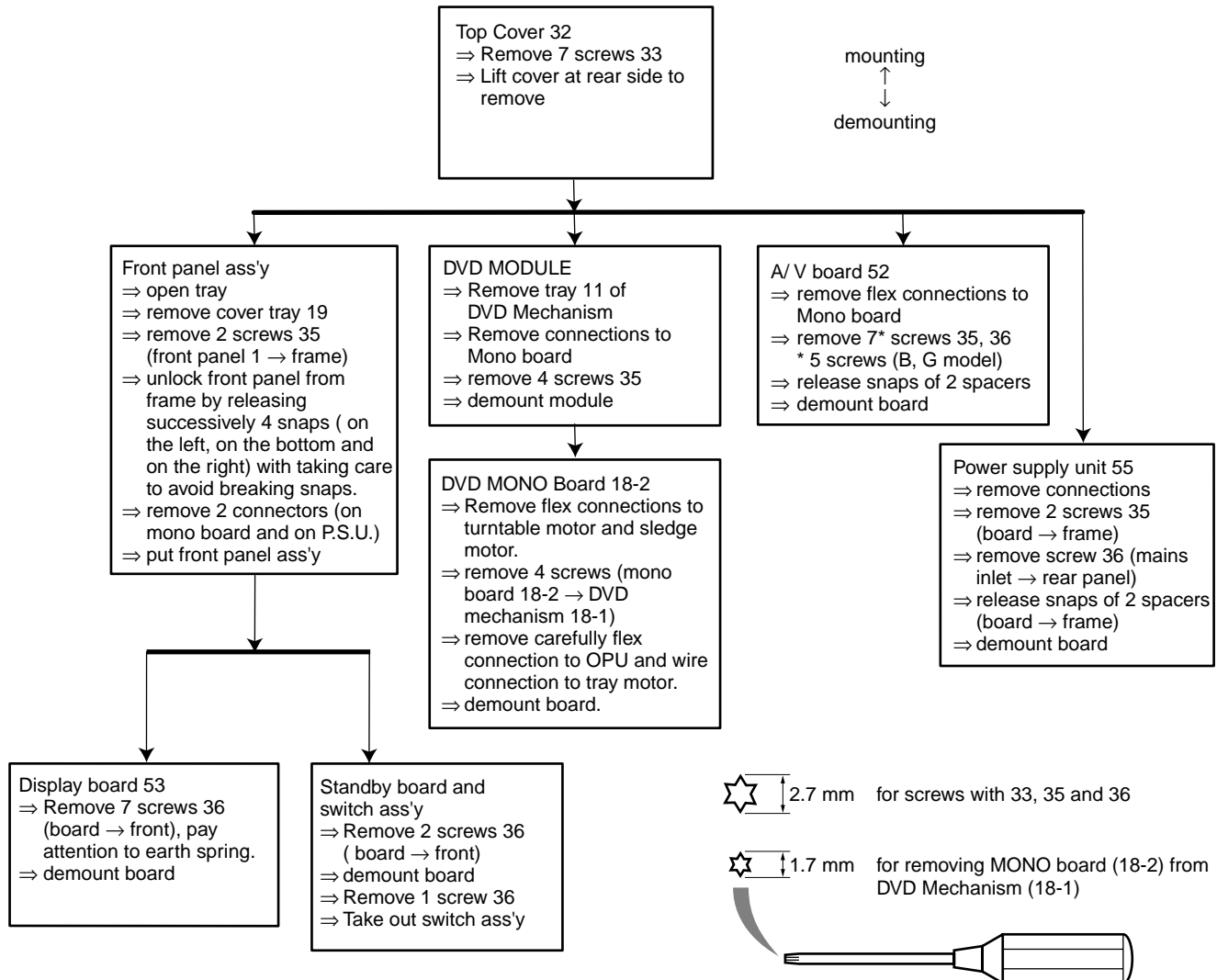

● The way to remove tray

1. Push left end of the lever under the tray toward the right by using screwdriver, move the tray by pulling it forward. (Fig. 1)
2. While lifting up the lever (①), move the left side of the tray by pulling it forward (②). (Fig. 2)
3. While lifting up the tray (③), remove the tray by pulling it forward (④). (Fig. 2)

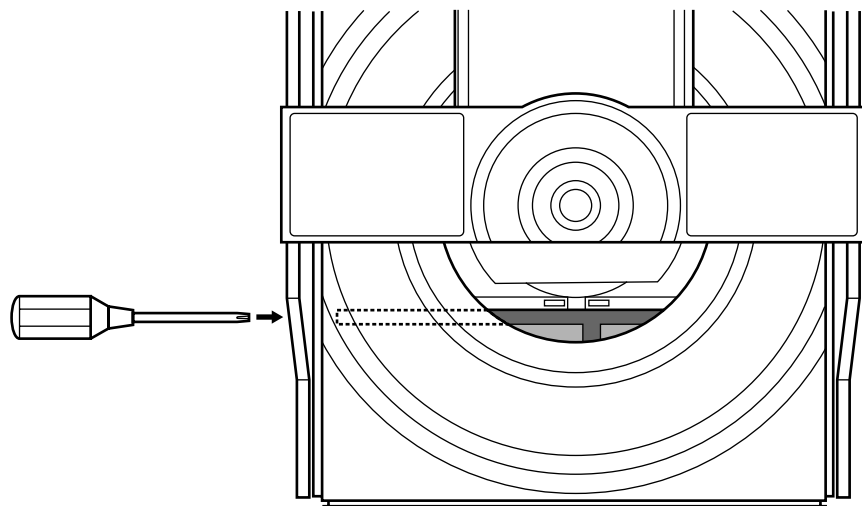

Fig. 1

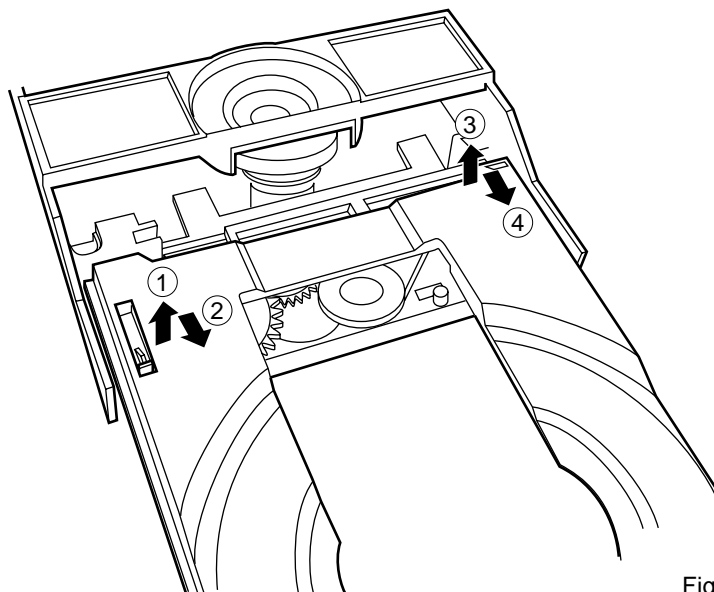

Fig. 2

■ SERVICE HINTS

Diagnostic software

In chapter "Diagnostic software", some tests are referring to the SCART functionality.

These tests are for sets with RGB-output.

For sets without RGB-output, no SCART connector is mounted.

In these sets, the SCART tests will automatically be skipped.

■ DIAGNOSTIC SOFTWARE : SCRIPT INTERFACES

1. DEALER SCRIPT

1.1 Purpose of Dealer Script

The dealer script can give a diagnosis on a standalone DVD player; no other equipment is needed to perform a number of hardware tests to check if the DVD player is faulty. The diagnosis is simply a "error" or "pass" message; no indication is given of faulty hardware modules. Only tests within the scope of the diagnostic software will be executed hence only faults within this scope can be detected.

1.2 Contents of Dealer Script

The dealer script executes all diagnostic nuclei that do not need any user interaction and are meaningful on a standalone DVD player.

The nuclei called in the dealer script are the following (the number after each nucleus name corresponds with the number being on the local display when the nucleus is executed during the dealer script):

Nucleus		Description
VideoColSetupComm	9	Checks the I2C interface with the RGB video processor on the Audio/Video board (only for DVD players with RGB video processor).
VideoScartSwComm	8	Checks the I2C interface with the scart switch on the Audio/Video board
PapChksFl	7	Calculate and verify checksum of FLASH memory.
PapDramWrR	6	Pattern test of all locations in the DRAM(s).
PapI2cDisp	5	Checks the I2C interface with the slave processor on the display PCB.
PapS2bEcho	4	Checks the I2C interface to the basic engine.
PapI2cNvram	3	Checks the I2C interface with the NVRAM.
PapNvramWrR	2	Pattern test of all locations in the NVRAM
CompSdramWrR	1	Pattern test of all locations in the SDRAM(s).

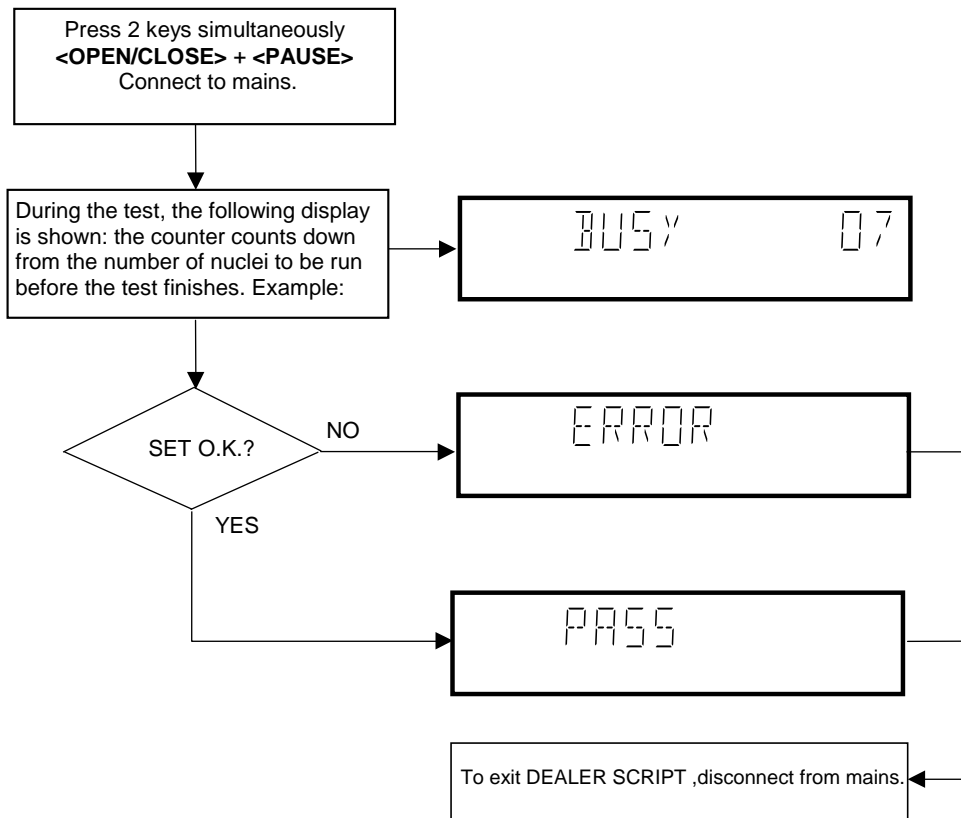

2. PLAYER SCRIPT

2.1 Purpose of Player Script

The Player script will give the opportunity to perform a test that will determine which of the DVD player's modules are faulty, to read the error log and error bits and to perform an endurance loop test. To successfully perform the tests, the DVD player must be connected to a TV set to check the output of a number of nuclei. For DVDv2b a multi-channel amplifier, a set of 6 boxes and an external video source are necessary to test. To be able to check results of certain nuclei, the player script expects some interaction of the user (i.e. to approve a test picture or a test sound). Some nuclei (e.g. nuclei that test functionality of the Basic Engine module) require that the DVD player itself is opened, to enable the user to observe moving parts and approve their movement visually. Only tests within the scope of the diagnostic software will be executed hence only faults within this scope can be detected.

2.2 Contents of Player Script

The player script contains all nuclei that are useful on a DVD player that is connected to a TV-set and help to determine which module of the DVD player is faulty, as well as to read out the contents of the error logs.

2.3 Structure of Player Script

The player script consists of a set of nuclei testing the three hardware modules in the DVD player: the Display PWB, the Digital PWB and the Basic Engine.

Nuclei run by the player test need some user interaction; in the next paragraph this interaction is described. The player test is done in two phases:

1. Interactive tests: this part of the player test depends strongly on user interaction and input to determine nucleus results and to progress through the full test. Reading the error log and error bits information can be useful to determine any errors that occurred recently during normal operation of the DVD player.
2. The loop test will perform the same nuclei as the dealer test, but it will loop through the list of nuclei indefinitely.

2.4 Survey

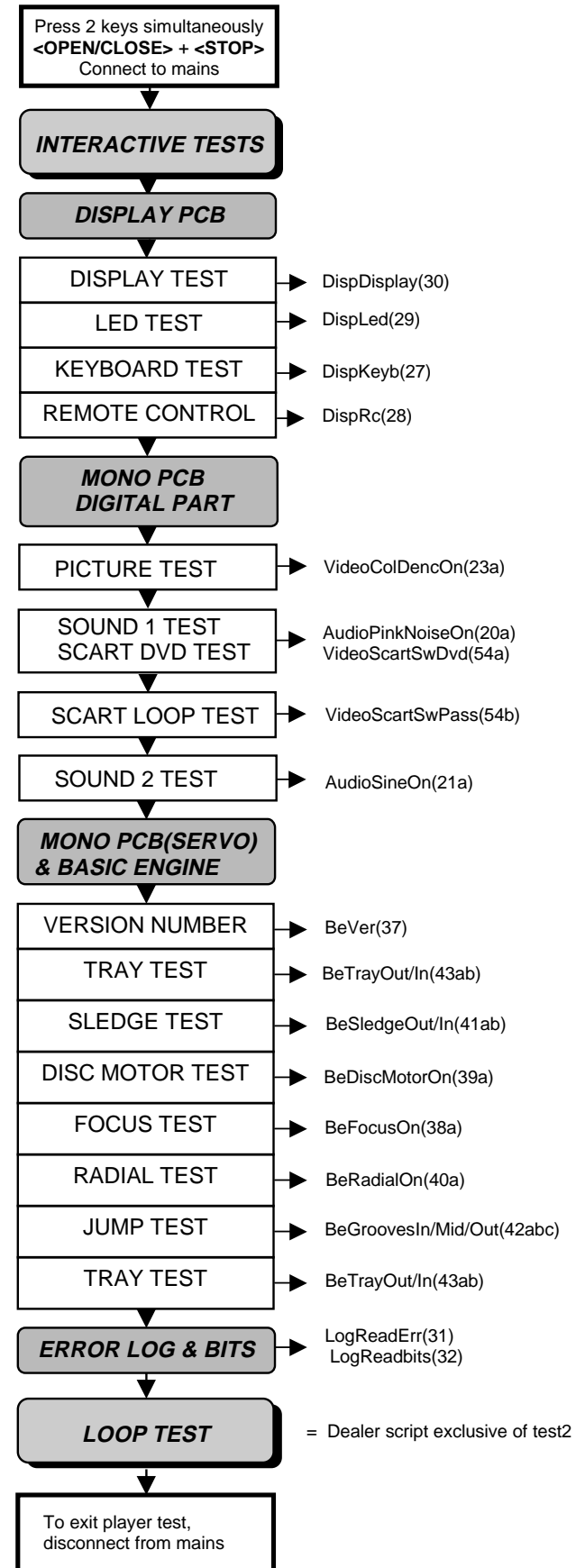

■ INTERACTIVE TESTS

1. DISPLAY PCB

1.1 DISPLAY TEST

The display test is performed by nucleus DispDisplay. By putting a series of test patterns on the local display, the local display is tested. To step through all different patterns, the user must either press PLAY (pattern is ok) or PAUSE (pattern was incorrect) to proceed to the next pattern. The display of patterns is continued in a cyclic manner until the user presses NEXT. If the user presses NEXT before all display patterns are tested, the DispDisplay nucleus will return TRUE (display test successful).

1.2 LED TEST

The LED(s) on the DVD player is (are) tested by nucleus DispLed. The user must check if the LED(s) is (are) lighted; if it is, press PLAY, if it is not, press PAUSE. By pressing NEXT the script will proceed to the next test. If the user presses NEXT before PLAY or PAUSE, the DispLed nucleus will return TRUE (LED test successful).

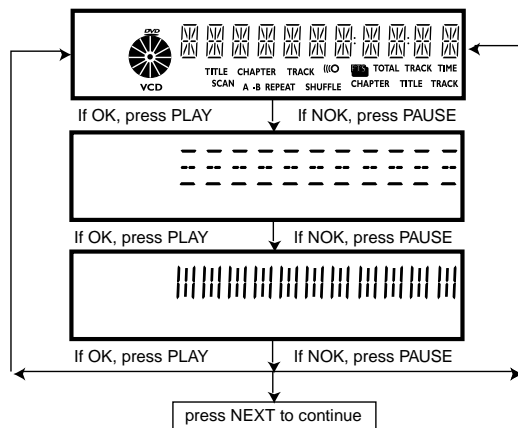

Figure 1

1.3 KEYBOARD TEST

The keyboard of the DVD player is tested by nucleus DispKeyb. The user is expected to press all keys on the local keyboard once. The code of the key pressed is shown on the local display (1 hexadecimal digit) immediately followed by a (hexadecimal) number indicating how many times that key has been pressed. Example of the local display during this test:

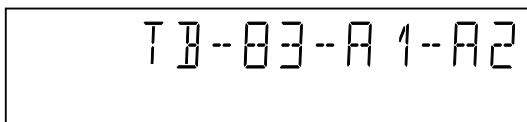

Figure 2

The key-codes displayed on the local display will scroll from right to left when the display gets full, the text "tb-" will remain on display.

key id.	key
0	PLAY
1	NEXT
2	PREVIOUS
3	PAUSE
4	STOP
5	OPEN / CLOSE
A	POWER (B, G models)

Figure 3

If any keys are detected more than once (due to hardware error), the key-code is displayed twice (or more), with the second digit increased by 1.

If the user does not press all keys minimally once (in any order), the DispKeys nucleus will return FALSE and cause an error in the overall result of the player script.

The user can leave the keyboard test by pressing the NEXT key on the local display of the DVD player for at least one full second.

The result of the keyboard test is shown on local display as follows:

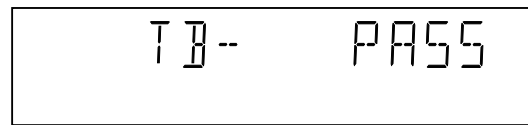

Figure 4

Or

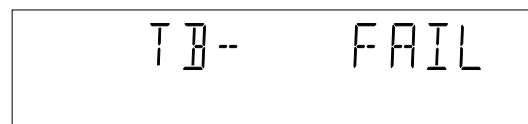

Figure 5

Pressing NEXT on the local keyboard again will proceed to the next text.

1.4 REMOTE CONTROL TEST

The remote control of the DVD player is tested by nucleus DispRc. The user must press any key on the remote control just once. The codes of the key pressed will be shown on the local display in hexadecimal format. Example:

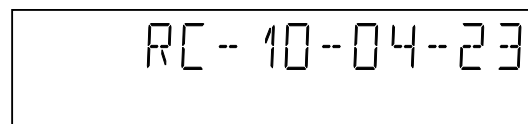

Figure 6

In this example 23 is the hexadecimal code of the pressed RC key. The user can leave the remote-control test by pressing NEXT on the local keyboard of the DVD player. The remote control test is successful if a code was received before the user pressed the NEXT key; pressing the NEXT key before pressing a key on the remote control gives an error in the remote control test (note that the remote control test will also fail if a key on the remote control was pressed but no code was received). The remote control test does not check upon the contents of the received code, that is it will not be checked if the received code matches the key pressed. If desired, the user can manually check this code by using a code-table for the remote control key-codes.

RC Key id	Hexadecimal code
STANDBY	C
STOP	31
PLAY	2C
PLAY BACKWARD	2D
PAUSE	30
STEP FORWARD	F6
STEP BACKWARD	F5
FORWARD	28
FORWARD 4X	DF
FORWARD 8X	E0
BACKWARD	29
BACKWARD 4X	DE
BACKWARD 8X	DD
SLOW	22
SLOW 2	D8
SLOW BACKWARD	23
SLOW BACKWARD 2	DB
NEXT	20
PREVIOUS	21
CURSOR UP	58
CURSOR DOWN	59
CURSOR LEFT	5A
CURSOR RIGHT	5B
OK	5C
0	0
1	1
2	2
3	3
4	4
5	5
6	6
7	7
8	8
9	9
TITLE/CHP	C8
ANGLE	85
AUDIO	4E
SUBTITLES	4B
SUBTITLE ON/OFF	E3
ROOT MENU	54
TITLE MENU	71
MENU	D1
SETUP MENU	82
ON SCREEN	F
RETURN	83
RESUME	D7
SCAN	2A
SHUFFLE	1C
REPEAT	1D
A/B REPEAT	3B
TOGGLE SCART	43
OPEN/CLOSE	42
FTS	FB
KARAOKE	E4
OPTION	FA
ZOOM	F7

Figure 7

After pressing NEXT, the result of the remote control test is displayed on the local display of the DVD player as follows:

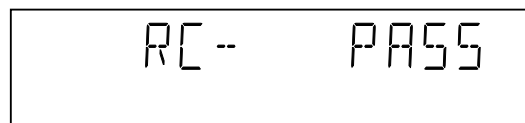

Figure 8

Or

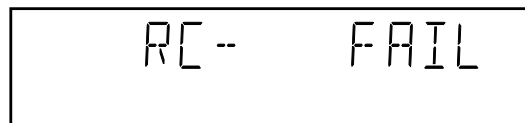

Figure 9

Pressing NEXT on the local keyboard again will proceed to the next test.

2 MONO PCB DIGITAL PART

2.1 PICTURE TEST

The picture test is performed by putting a predefined picture (colour bar) on the display (nucleus VideoColDencOn) and asking the user for confirmation. The display shows the following message:

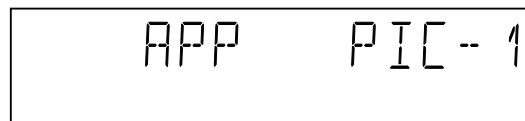

Figure 10

By pressing PLAY, the user confirms the test; pressing PAUSE will indicate the picture was invisible or incorrect. Pressing NEXT will proceed to the next test

2.2 SOUND 1 & SCART DVD TEST

The first soundtest is performed by starting a pink noise sound that needs confirmation from the user (nucleus AudioPinkNoiseOn); the display shows the following message very shortly:

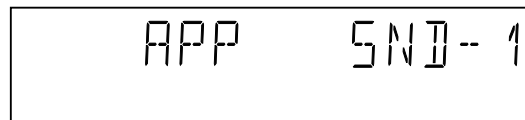

Figure 11

This sound will only be audible from version cut3.1 of Sti5505(item7503 on mono board) onwards. After starting up sound 1, SCART loop-trough will be simultaneously active during this test. SCART loop-trough will be measured with the aid of an external video source. When entering the SCART loop-trough, the local display indicates:

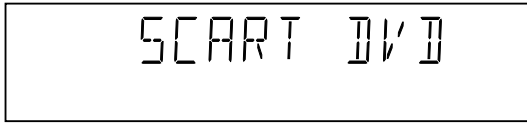

Figure 12

On the TV screen, a colour bar (generated by nucleus VideoColDencOn) is visual and the internally generated pinknoise is audible. By pressing PLAY, the user confirms the test; pressing PAUSE will indicate the sound was inaudible or incorrect. Pressing NEXT will proceed to the next test; if the user presses NEXT without pressing PLAY or PAUSE first, the result of this test will be TRUE (sound ok). By pressing the NEXT button, there will be switched over to the external source, this must become now visible on the TV screen (using the SCART). The local display indicates:



Figure 13

The internally generated colour bar is still available on the CVBS and Y/C outputs. And the pinknoise-signal is still available on the cinch audio outputs. By pressing the PREV button, the internal generated colour bar becomes visual again.

The test can be left by pressing the NEXT key for more than one second.

2.3 SOUND 2 TEST

The second soundtest is performed by producing a sine sound (nucleus AudioSineOn). The signal can be stopped by pressing the STOP-key. The display shows the following message:



Figure 14

By pressing PLAY, the user confirms the test; pressing PAUSE will indicate that something went wrong. Pressing NEXT will proceed to the next; if the user presses NEXT without pressing PLAY or PAUSE first, the result of this test will be TRUE (sound ok).

3 BASIC ENGINE

note) Basic engine means DVD mechanism.

3.1 VERSION NUMBER

In the basic engine tests, the version number of the Basic Engine will be shown first, as the following example:

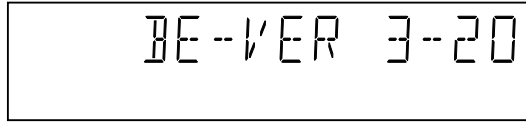

Figure 15

By pressing the NEXT key, the Basic Engine tests are started.

3.2 TRAY TEST

First, the tray is tested. The purpose of this test is also to give the user the opportunity to put a disc in the tray of the DVD player. Some tests on the Basic Engine require that a disc (e.g. DVD MPTD test disc) is present in the player. At the end of the Basic Engine tests, this tray test will be repeated solely to enable the user to remove the disc in the tray. The local display looks as follows:

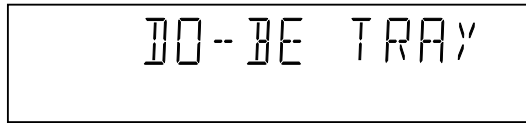

Figure 16

By pressing PLAY or PAUSE, the user can toggle the position of the tray. Note that this test will not contribute to the test result of the Basic Engine. Pressing NEXT will proceed to the next test, after the tray has been closed (by the software) if it was open.

3.3 SLEDGE TEST(visual test)

The second Basic Engine test tests the sledge; the user can move the sledge as many times as desired by using PLAY (nucleus BeSledgeOut) and PAUSE (nucleus BeSledgeIn).

Pressing NEXT on the local keyboard proceeds to the next test.

Note that this test will not contribute to the test result of the Basic Engine. The local display looks as follows during the sledge test:

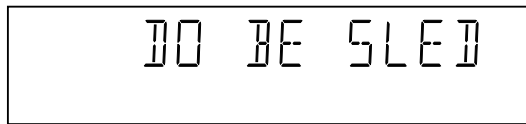

Figure 17

3.4 DISC MOTOR TEST(visual test)

The third Basic Engine test tests the disc motor (nucleus BeDiscMotorOn); the local display looks as follows:

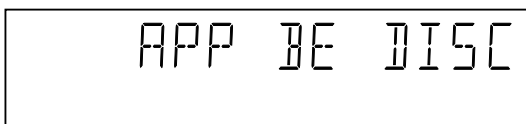

Figure 18

By pressing PLAY, the user confirms that the disc motor is running; pressing PAUSE indicates the disc motor does not work. Pressing NEXT proceeds to the next test, after a reset of the disc motor (nucleus BeDiscMotorOff). If the user presses NEXT before pressing PLAY or PAUSE, the result of this test will be TRUE (disc motor is running).

3.5 FOCUS TEST(visual test)

The fourth Basic Engine test tests the focussing; first focussing is turned on by calling nucleus BeFocusOn. The display looks as follows:

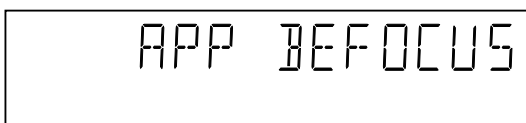

Figure 19

By pressing PLAY, the user confirms that the focussing was successful; pressing PAUSE indicates a focussing failure.

Pressing NEXT proceeds to the next test after a reset of the focussing (nucleus BeFocusOff); if NEXT is pressed before PLAY or PAUSE, the result of this test will be TRUE (focus successful).

3.6 RADIAL TEST(visual & listening test)

The fifth Basic Engine test tests the radial functionality (nucleus BeRadialOn); the local display looks as follows:

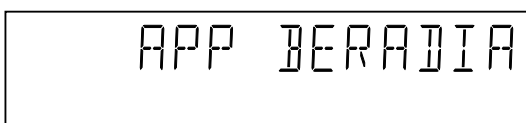

Figure 20

By pressing PLAY, the user confirms that the radial function worked; pressing PAUSE indicates the function does not work.

Pressing NEXT proceeds to the next test, after a reset of the radial (nucleus BeRadialOff). If the user presses NEXT before pressing PLAY or PAUSE, the result of this test will be TRUE (radial successful).

3.7 JUMP TEST(listening test)

The sixth and last Basic Engine test tests the jumping by calling nuclei BeGroovesIn, BeGroovesMid and BeGroovesOut.

During this test, the local display looks as follows:

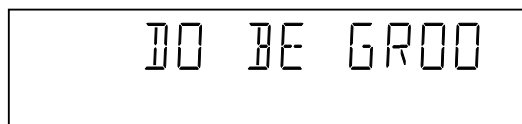

Figure 21

The user can switch between the three different types of groove settings by pressing PLAY (forward to next nucleus in the list In-Mid-Out) or PAUSE (backward in the list In-Mid-Out).

This is done in a cyclic manner; note that this test will not contribute to the test result of the Basic Engine. Pressing NEXT proceeds to the next test, after the disc motor has been shut off with a call to nucleus BeDiscMotorOff.

3.8 TRAY TEST

As a last action for the Basic Engine tests, the tray test is repeated. The local display looks as follows:

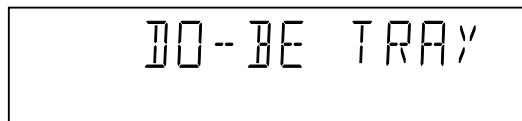

Figure 22

This test is meant to give the user the opportunity to remove the disc in the tray. The tray position can be toggled using the PLAY and PAUSE key. The tray will be closed (by the software, if it is open) before proceeding to the next test when the user presses the NEXT key.

3.9 ERROR LOG

Reading the error log and error bits information can be useful to determine any errors that occurred recently during normal operation of the DVD player. Reading the error log is done by nucleus LogReadErr. The display during the errorlog readout looks as follows :

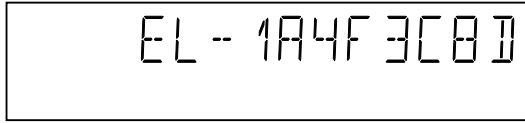

Figure 23

By pressing PLAY or PAUSE, the user can move forward or backward (respectively) through the logged error codes. The highlighted number indicates which errorcode is currently on display (in the example above, errorcode number 4 is displayed). If "0000" is displayed at all positions, the error log is empty. Display of the logged errors is done in a cyclic manner.

The errorcode with the lowest highlighted number is the most recent. By pressing NEXT on the local keyboard, the user can proceed to the next test.

3.10 ERROR BITS

Reading the error bits is done by nucleus LogReadBits. The display during the errorbits readout looks as follows:

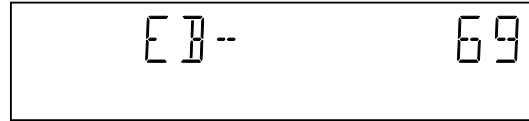

Figure 24

Only the set errorbits will be shown by their (decimal) number.

Refer to the appropriate documentation for the explanation of each bit number. If the display only shows "EB-0", no error bits were set. By pressing NEXT, the user can continue to the next test.

See table below:

Error log / bits table	Read ERROR LOG in player script	Read ERROR BITS in player script
Basic engine errors	Value:	Value:
Command to the Basic Engine not allowed in this state or unknown command	150101	8
Parameter(s) from the command to the Basic Engine is not valid	150102	7
Sledge could not be moved to the inner home position	150103	6
Focus failure	150104	5
Turntable motor speed could not be reached within timeout	150105	4
Radial servo could not get on track on the disc	150106	3
PLL could not lock in the accessing or tracking state	150107	2
Subcode or sector information could not be read	150108	1
requested subcode could not be found	150109	16
Tray could not be closed or opened completely	15010A	15
TOC could not be read within timeout	15010B	14
The requested seek on the disc could not be executed	15010C	13
A requested lead-in is not on the disc	15010D	12
A non existing burst cutting area is requested	15010E	11
S2b communication error	1501F0	10
S2b communication error	1501F1	9
S2b communication error	1501F3	24
S2b communication error	1501F4	23
S2b communication error	1501F5	22
Digital PWB errors		
Communication error with the Sti 5505	90000	32
Communication error with the Sti 5505	90001	31
Disply processor errors		
Communication error with the display processor	190000	40

4. LOOP TEST

At the start of the loop test, the display will show the result of the interactive player test:

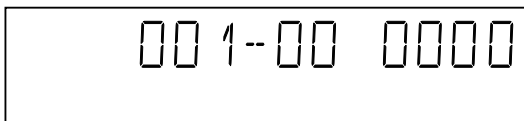

Figure 25

The left side of the display contains a 3-digit code, which can have a value between 000 and 111. These values are to be interpreted as follows:

Displayed Value	Indication for each module		
	Basic Engine	Mono PCB	Display PCB
000	ok	ok	ok
001	ok	ok	faulty
010	ok	faulty	ok
011	ok	faulty	faulty
100	faulty	ok	ok
101	faulty	ok	faulty
110	faulty	faulty	ok
111	faulty	faulty	faulty

Figure 26

The loop test will perform the same nuclei as the dealer test, but it will loop through the list of nuclei indefinitely. The display of the DVD player will display not only the three digits indicating correct/faulty modules and the last found error code (as mentioned, faults are detected as far as they can be within the scope of the diagnostic software), but also a loop counter indicating how many times the loop has been gone through.

Example:

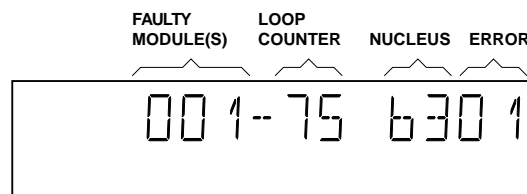

Figure 27

The number after the hyphen indicates the number of times the loop test has been performed; the 4 digits at the right side of the display show the last error that was found when running the loop test: the leftmost two digits of this code indicate which nucleus resulted in a fault; the rightmost two digits refer to the faultcode within that nucleus. For further explanation of this error code, see list of error codes below.

ERROR CODES LOOP TEST

ERROR CODE	NUCLEUS NUMBER	ERROR DESCRIPTION
0601	6	Calculated checksum of FLASH is not correct
0901	9	The DVD DRAM is faulty
1104	11	I2C bus busy before start
1102		NVRAM access time-out
1103		No NVRAM Acknowledge
1104		NVRAM reply time-out
1201	12	I2C bus busy
1202		I2C bus not working
1203		Slave controller not responding
1204		Slave response is not correct
1301	13	Parity error from basic engine to serial
1302		Parity error from serial to basic engine
1303		No communication between serial and basic engine
1304		Communication time-out error
1601	16	The SDRAM is faulty

Figure 28

5. Servicing DVD module and MONO board

5.1 Reset of Virgin Mode

After the player has been powered up for test by the dealer, it would have gone through the Virgin Mode. It is possible to reset the settings made during that mode before the delivery of player to the customer. This can be done as shown in the following diagram:

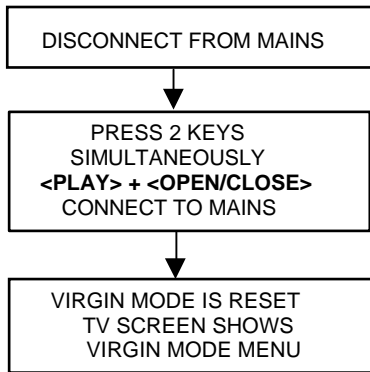

Figure 29

5.2 Trade Mode

When the player is in Trade Mode, the player cannot be controlled by means of the front key buttons, but only by means of the remote control.

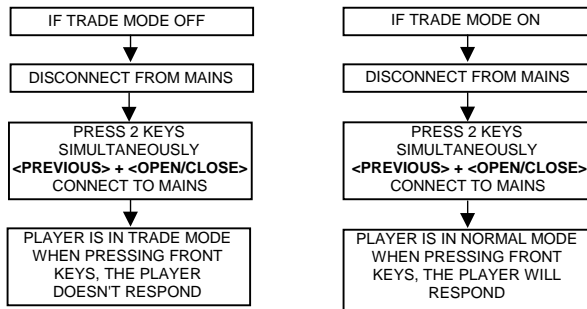

Figure 30

TEST INSTRUCTIONS DISPLAY BOARD

1. Display board

1.1 Introduction

These test instructions are written for all versions of the display PCB.

The contents of the PCB can be split up into next blocks:

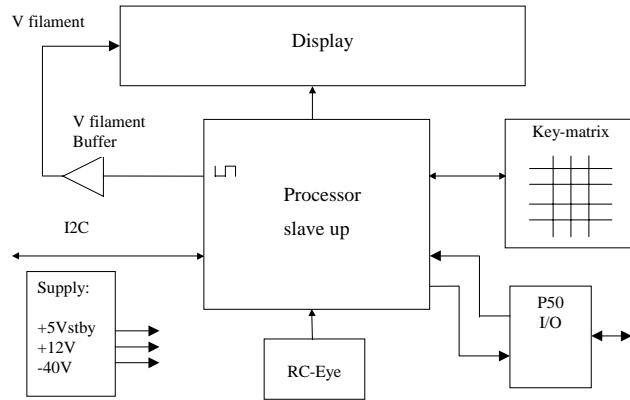

Figure 1

1.2 Functionality description:

The essential component of the display PCB is the μP (slave).

This slave works on an 8MHz resonator and has a reset circuit that is triggered by the +5Vstby. After the reset pulse, the standby control line will release the reset of the host μP . This host μP will then initialize the slave. In addition, when going to stand-by, the slave will put the host μP in reset. When the slave receives the right IR or key code to leave the standby mode, the reset of the host μP will be released.

Other slave functions are:

- Square signal generator to generate the filament voltage, which is required for an AC FTD.
- Generating the grid and segment scanning for the FTD.
- Generating a scanning grid for the keys (separated from display scanning).
- Having inputs for RC (RC5 and RC6) and P50 (P50 controller is built in).

1.3 Reset

Check next reset timing with an oscilloscope at pin 10 of the microprocessor.

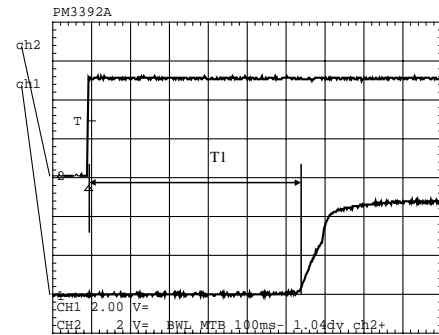

Figure 2

Timing: $400\text{msec} < T1 > 700\text{msec}$.

CH1: +5Vstby voltage at power on.

CH2: Voltage at pin 10.

1.4 Display steering

Check next timing and level for all grid-lines (G1 r G14).

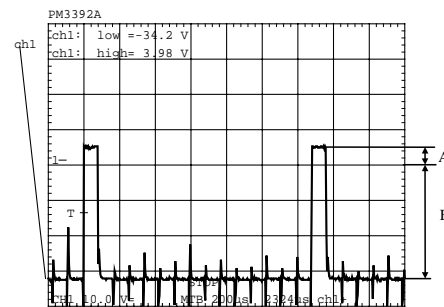

Figure 3

1. Check level A: +4V5 +/-10% for grid lines 1 => 11
2. Check level A: +4V0 +/-10% for grid lines 12 => 14
3. Check level B: -33V +/-10%
4. Check timing and levels of segment-lines P1 => P10:

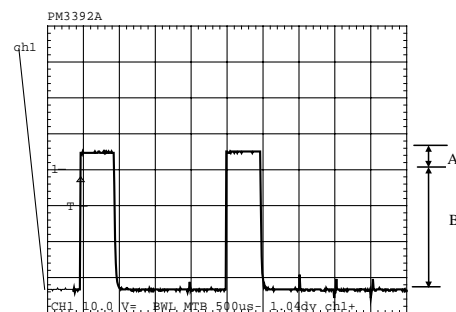

Figure 4

Level A: +4V5 +/-10%

Level B: -33V +/-10%

The data on these segment lines depend on the characters that are displayed.

The characters can be set by sending I2C commands to the display.

See the Slave URS how to send a display command.

1.5 Key-matrix

Connect a extra 10kpull-up resistor to pin 36 en 37 of the μ P and check next matrix scanning at these pins.

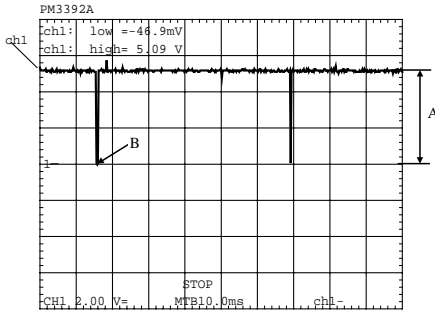

Figure 5

Level A: 5.0V +/-7%

Level B: 0V +/-200mV

Check matrix scanning from pin 26 until 33 of the μ P.

The results should be the same as the diagram above.

1.6 I.R. receiver

Check at pin 23 of the μ P if this line switches from low (< 0.3V) to high (> 4.5V), while pressing a key on a Philips RC5 or RC6 remote control.

1.7 Karaoke interface

The karaoke interface (4 lines) is a single direction communication.

This means that it consists of four μ P output lines.

The interface can be checked by setting or resetting these output-ports via the I2C bus.

Send next command via the I2C bus:

- Address : 0x70
- Command byte : 0x24
- Data byte : xxxxabcd
- Where : a = Karaoke reset.
- : b = Karaoke data.
- : c = Karaoke clock.
- : d = Karaoke strobe.

1.8 P50 interface

P50 is a bi-directional serial interface, which is used for communication between video equipment. For European sets, this communication goes via pin 10 of the scart-bus. In other regions, it can be a cinch bus at the back of the set.

1. Keep the μ P in reset by short-circuiting emitter and collector of transistor 7108, via resistor 3100 and 3104 transistor 7101 is switched on.
2. Check the voltage at the P50 output connector 1118-5: < 200mV.

When the reset is released the μ P output-pin becomes low and transistor 7101 is switched off.

1. Check the voltage at the P50 output connector 1118-5: 4.9V +/-5%.
2. Check also the μ P P50 input (μ P pin 20): 5V +/-5%.
3. Connect the P50 line (connector 1118-5) to ground.
4. Check again the μ P P50 input (μ P pin 20): <0.3V.

■ TROUBLESHOOTING

Display board

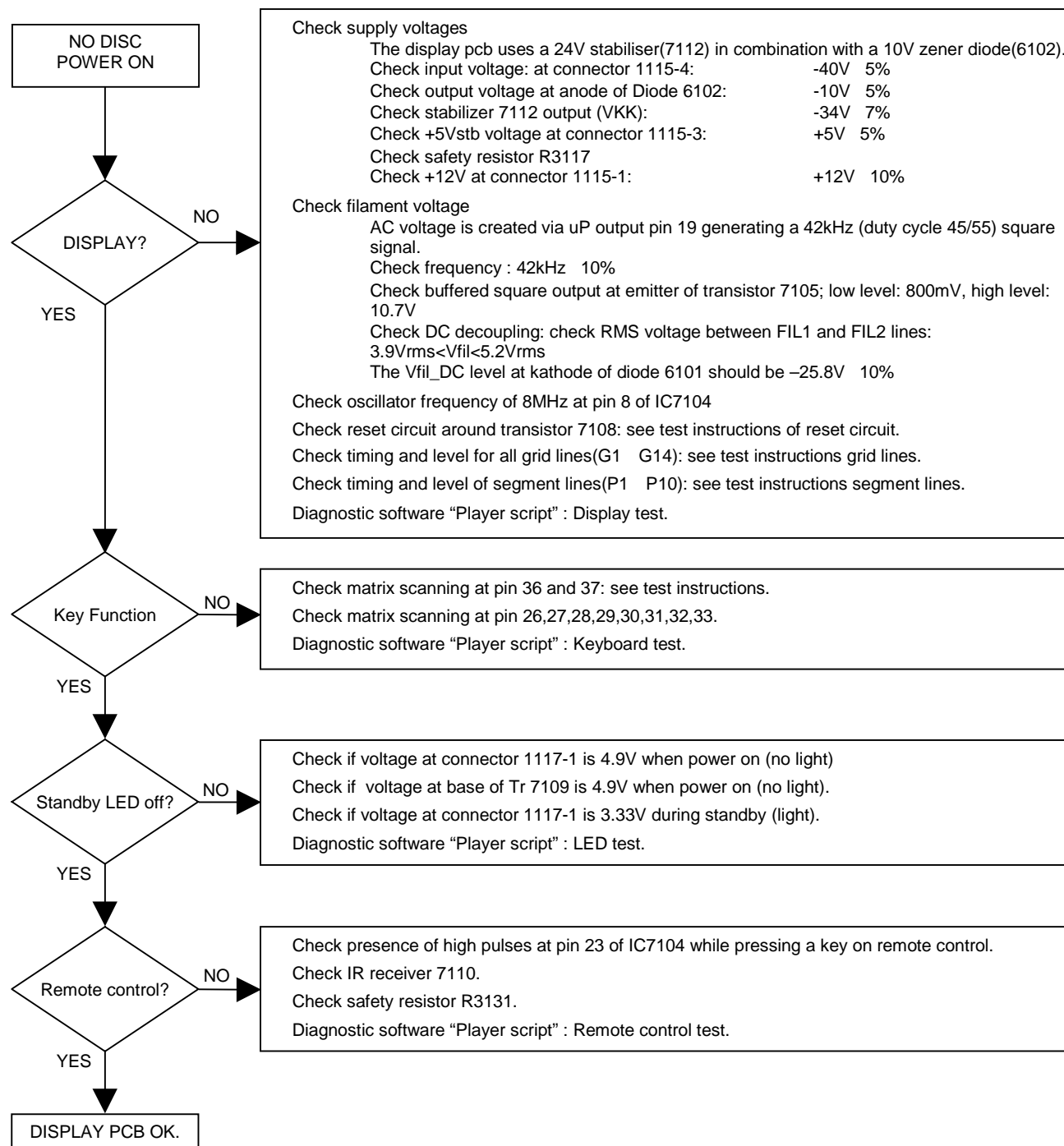

A/V board (B, G models)

Testing of A/ V board can be done using diagnostic software “Player script”.

Mono board is used to generate a sinus with the soundtest SND- 2 or a VIDEO signal with the picture test PIC- 1.

See description in chapter “Diagnostic Software : Script Interfaces”

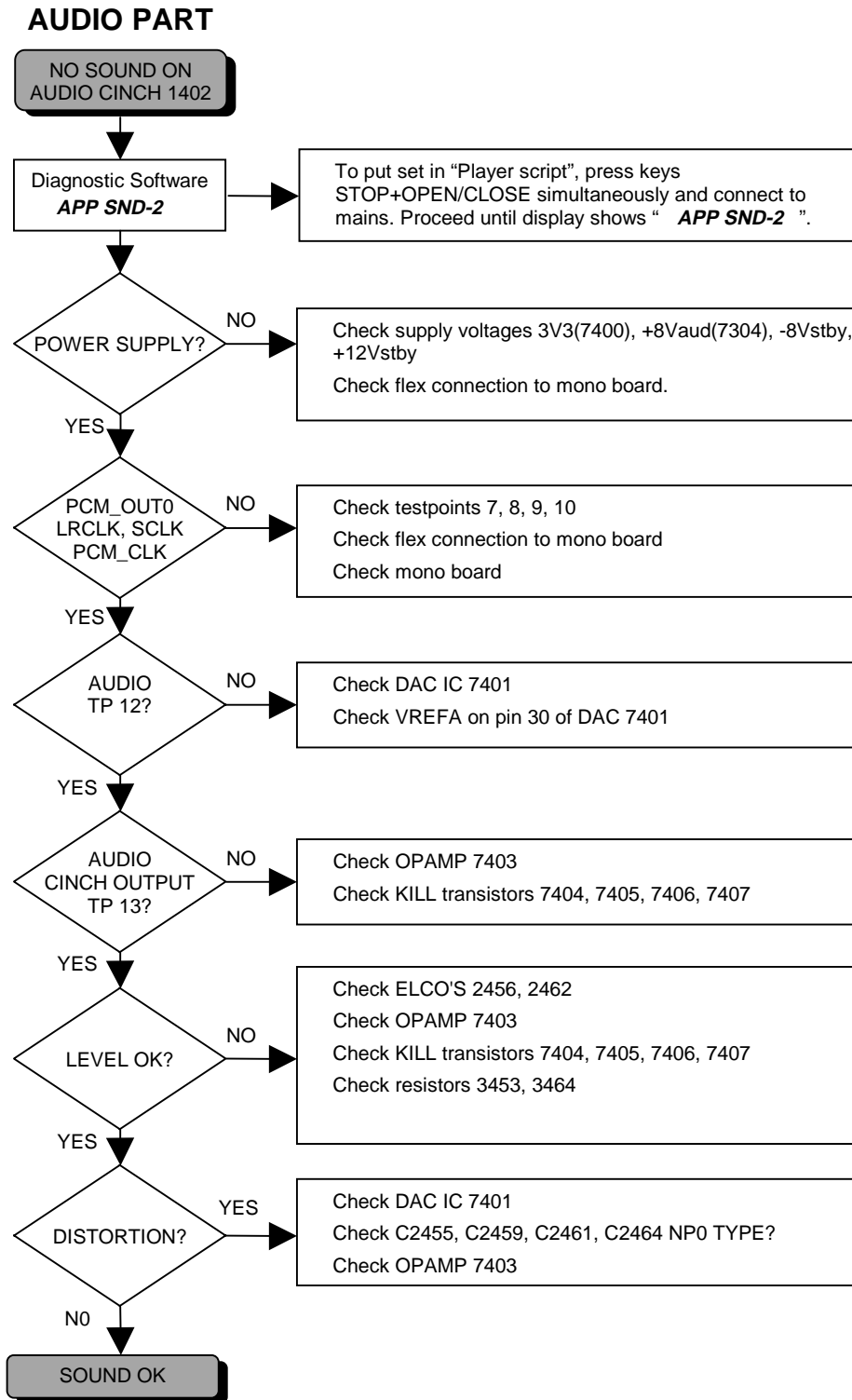

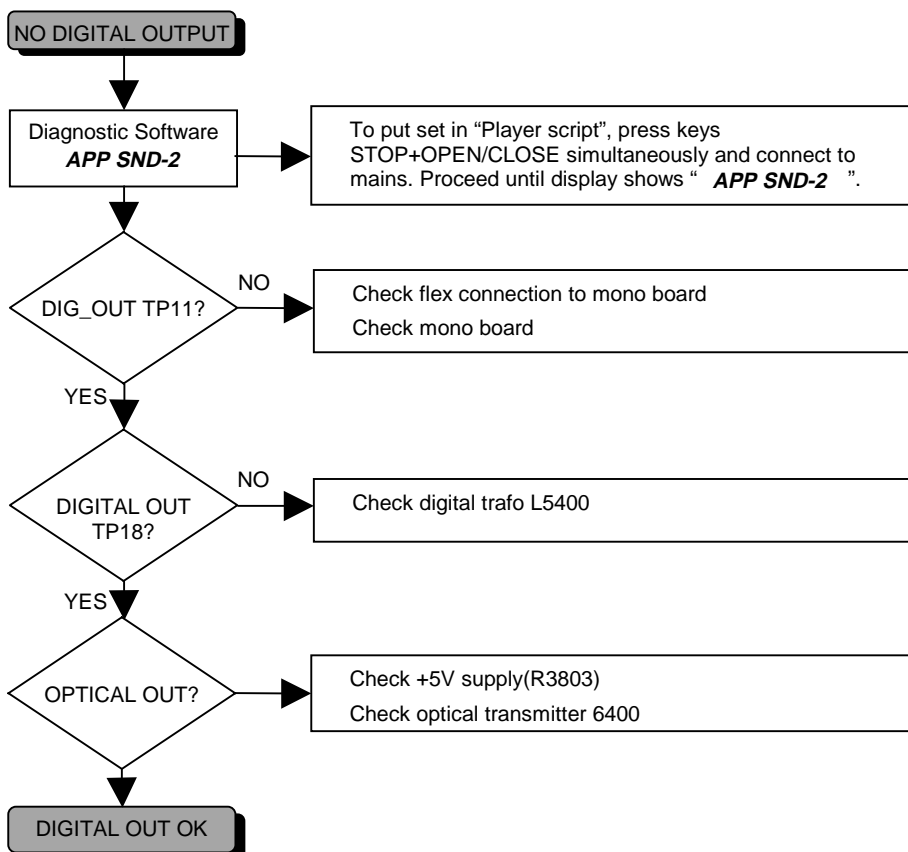
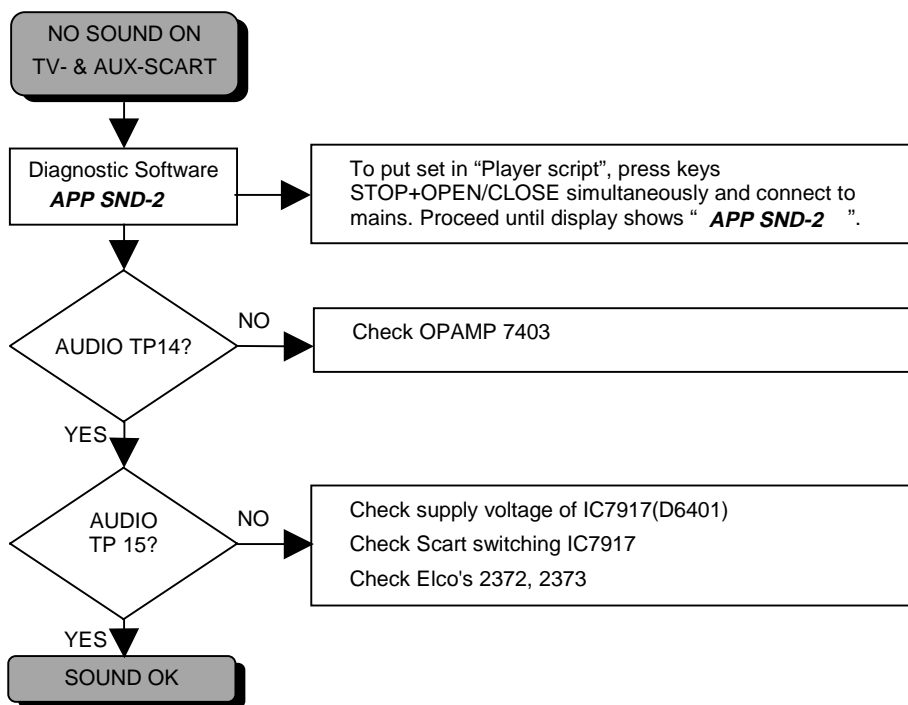

VIDEO PART

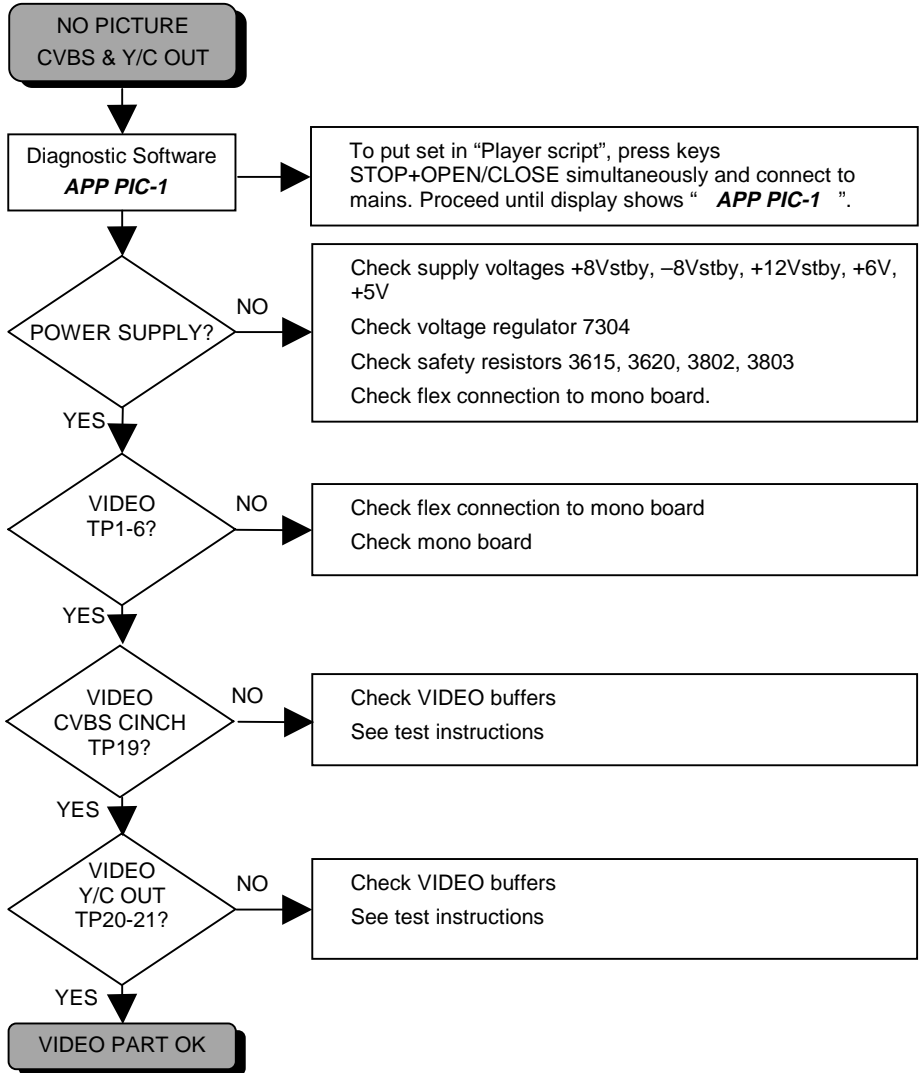

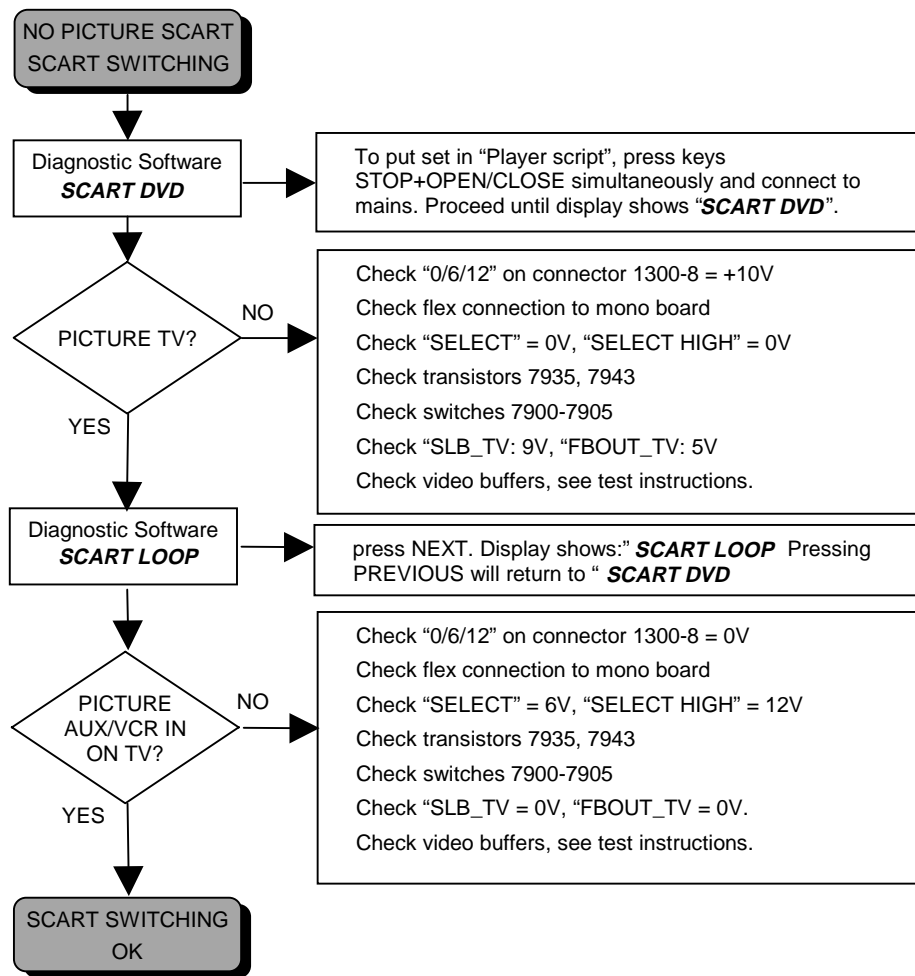

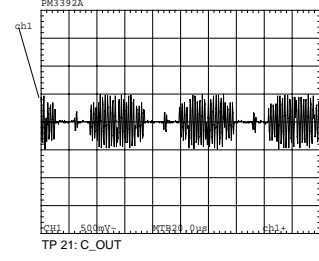
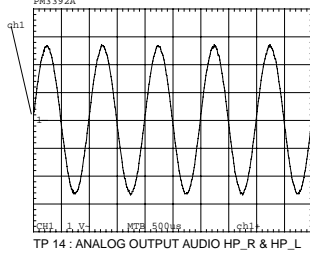
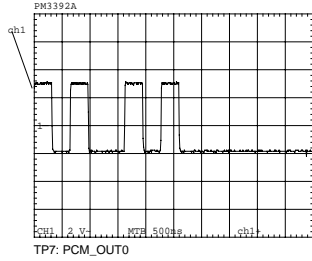
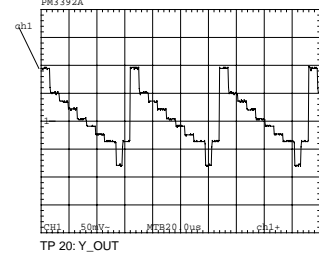
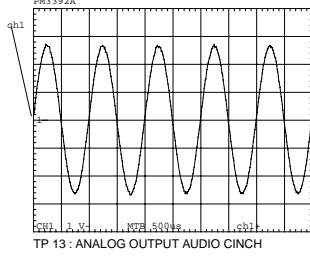
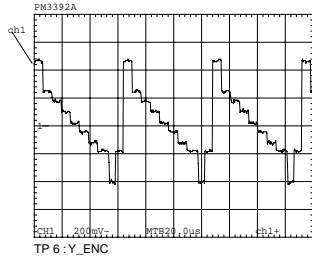
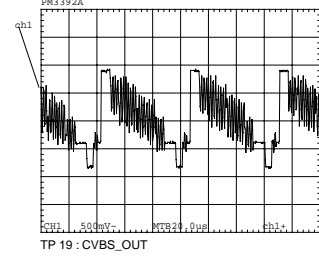
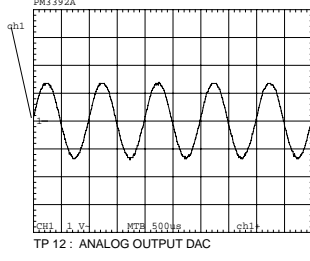
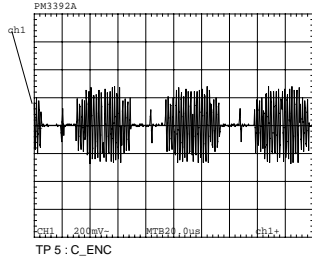
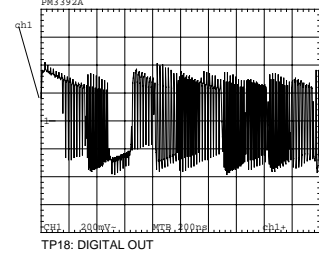
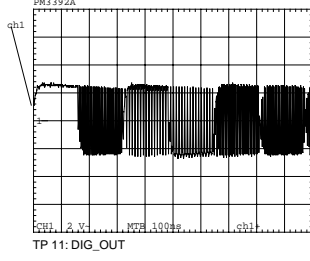
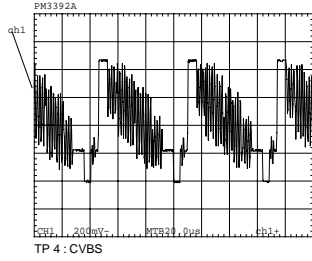
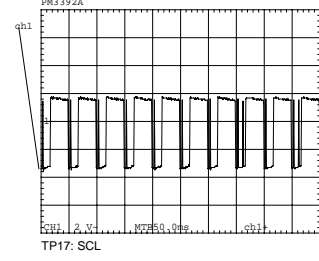
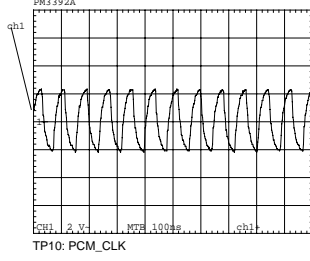
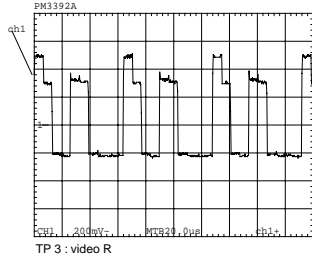
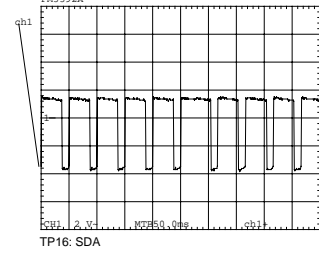
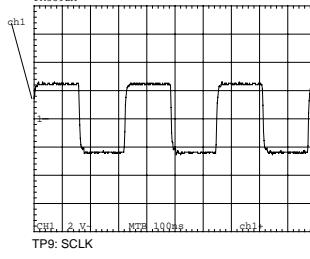
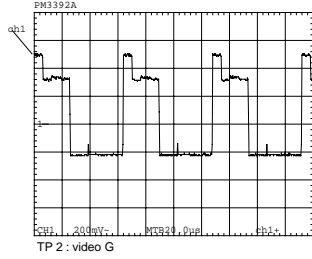
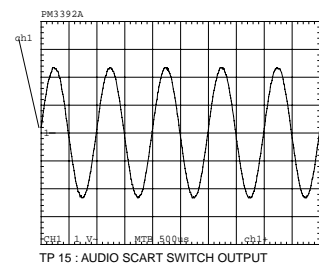
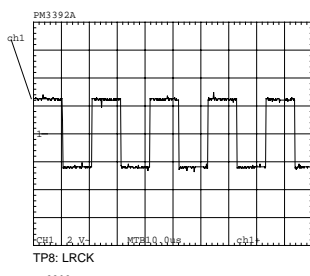
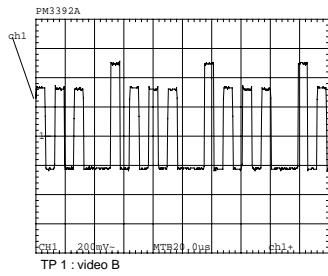

■ TECHNICAL SPECIFICATIONS DVD MODULE

1. Connections

1.1 Connector 1600 : Supply input connector.

1. +3.3Vstby
2. +3.3Vstby
3. +5V
4. +5Vstby
5. Vreserved
6. GND
7. GND
8. GND
9. -8Vstby
10. Standby control line
11. +12Vstby
12. GND

1.2 Connector 1603 : A/V 1 connector.

1. P50
2. Blue Video
3. Green Video
4. GND
5. Red Video
6. CVBS
7. GND
8. Slow blanking scart
9. -8Vstby
10. +5V
11. +5V
12. Audio mute
13. GND
14. I2S data0 out
15. I2S wordselect
16. I2S bitclock
17. GND
18. I2S systemclock
19. Center_on
20. Kar_bypass
21. Kar_bypass
22. GND

1.3 Connector 1604 : A/V 2 connector.

1. GND
2. Hor. sync.
3. GND
4. I2S data 2 out
5. GND
6. I2S data 1 out
7. -8Vstby
8. I2C clock
9. +12Vstby
10. I2C data
11. Vreserved
12. +3.3V
13. GND
14. C video
15. GND
16. Y video

1.4 Connector 1501 : I2C interface connector.

1. I2C clock
2. GND
3. I2C data
4. Standby control line
5. P50

1.5 Connector 1602 : Service connector.

1. TXD
2. Service activation
3. RXD
4. Reserved for RTS
5. 5 : GND
6. Reserved for CTS
7. +5V

2. Signal specifications

This the specification of all signals as described under "Connections"

H = +5V ±0.5V

h = 3.3V ±0.3V

L = 0V ±0.5V

I = 0V ±0.3V

Stby	:	If the set supports a "standby" function, all supply voltages marked with "stby" have to stay on during standby.
Standby control line	:	HStandby mode : LOn mode.
P50	:	Connection between front and A/V board, and can be used as P50 signal line. The signal is not connected to the module electronics.
Slow blanking scart	:	This signal switches between : 0V (220output impedance) : 12Vstby/2 (455output impedance) : 12vstby (690output impedance)
Audio mute	:	Can be used for audio mute transistors during stop or power on/off. : Mute on : +5Vstby : Mute off : -8Vstby via a 10k resistor.
I2S data0 out	:	I2S front data output. : Level h/l
I2S wordselect / I2S bitclock	:	I2S timing signals : Level h/l

I2S systemclock	: 256xFS audio systemclock. : Level H/L
Kar_bypass	: Bypasses the karaoke chip on the A/V board. : Bypass active H : Bypass off L
Center_on	: Switches the center audio to the scart output. : Center to scart h : L/R to scart l
SPDIF out	: Digital audio output : Level H/L
Hor. Sync	: Video Horizontal synchronisation : Level h/l
I2S data1 out	: I2S surround data output. : Level : h/l.
I2S data2 out	: I2S center/sub data output. : Level h/l.
I2C clock / I2C data	: I2C databus : Level : H/L
TXD / RXD / RTS / CTS	: Service UART to be connected direct to PC serial input. : Output levels H/L : Input levels RS232 compliant
Service activation	: Signal open Normal module start-up : Signal tied to GND Module start-up in service mode.
Vreserved	: Reserved in case the A/V board requires an extra supply voltage. : This supply is limited by a positive polarized 47uF/16V elco +100nF/16V.

3. Performance:

3.1 Digital output

CDDA/LPCM	: According IEC958
MPEG1 is converted to LPCM	:
MPEG2, AC3 audio.	: According IEC1937
DTS.	: According IEC61937 Amendment 1. : Digital output level is 0V / 5V with GND as reference. To meet the standards a decouple circuit is necessary.

3.2 I2S output

Accuracy	: Up to 24bit.
Sample rate	: 44.1kHz / 48kHz.
Standard	: Philips I2S output
Number of I2S outputs	: 3 (6 channel : Front / Surround / Center-Bass)
Deemphasis	: Already processed in module.
Audio source streams	: CDDA / MPEG1 / LPCM / MPEG2 / AC3 : No DTS decoding.
Audio trick modes	: Dolby Pro Logic (multichannel downmix on front output) : 3D sound.

3.3 Analog output

The module has no analog audio output.	: The analog audio specification will be determined by the external DAC circuit.
--	--

3.4 Video.

Standards	: The video output standard will follow the source material. : The OSD standard is switchable between PAL or NTSC.
Outputs	: The module has 6 analog outputs (3 f o r m a t s) : Y/ C C V B S RGB.
Specification.	: The output is fully according PQR3 IMS except : Output load >1kto GND / Cap. load <47pF. : Level 0.5Vpp with 100% white : DC-levelSync bottom = -0.65V ±10% : Some specification points are significantly better then PQR3 : SNR on all video outputs is better than 60dB. : Video bandwidth >5MHz (±3dB)

■ LIST OF ABBREVIATIONS

B	Buffered Video input Blue from DVD monoboard	Y_ENC	Buffered Luma input from DVD monoboard
BC_AUX	Blue or Chroma input from AUX-scart	YCVBSIN_AUX	Luma or CVBS input from AUX-scart
BC_TV	Blue or Chroma output to TV-scart	YCVBSIN_TV	Luma or CVBS input from TV-scart
C_ENC	Buffered Chroma input from DVD monoboard	YCVBSOUT_AUX	Luma or CVBS output to AUX-scart
CVBS	Buffered Composite video input from DVD monoboard	YCVBSOUT_TV	Luma or CVBS output to TV-scart
DC_OFF	Control signal to switch off -5Vstby and +12Vstby during standby	0/6/12	Scart switch control signal A/V board. 0V : loop through (AUX to TV), 6V : play 16:9 format, 12V : play 4:3 format
DIG_OUT	Digital out		
FBIN_AUX	Fast blanking input from AUX-scart		
FBOUT_TV	Fast blanking output to TV-scart		
G	Buffered Video input Green from DVD monoboard		
GIN_AUX	Video input Green from AUX-scart		
GOUT_TV	Video output Green to TV-scart		
HP_L	Audio output left to headphone and audio scart switch TEA6420		
HP_R	Audio output right to headphone and audio scart switch TEA6420		
KILL	Kill control signal for audio outputs and for soft mute of DAC		
LIN_AUX	Audio input left from AUX-scart		
LIN_TV	Audio input left from TV-scart		
LOUT_AUX	Audio output left to AUX-scart		
LOUT_TV	Audio output left to TV-scart		
LRCLK	Left/Right clock		
PCM_CLK	Audio system clock for DAC		
PCM_OUT0	Audio serial output data		
R	Buffered Video input Red from DVD monoboard		
RCIN_TV	Red or Chroma input from TV-scart		
RCOUT_TV	Red or Chroma output to TV-scart		
RIN_AUX	Audio input right from AUX-scart		
RIN_TV	Audio input right from TV-scart		
ROUT_AUX	Audio output right to AUX-scart		
ROUT_TV	Audio output right to TV-scart		
SCL	I2C bus clock		
SCLK	Audio serial bit clock		
SDA	I2C bus data		
SELECT	Control signal for video scart switches; high = TV ,low = AUX		
SELECT_HIGH	Control signal for switching fast blanking and slow blanking signals; high = TV, low = AUX		
SLB_AUX	Slow blanking control signal from AUX-scart		
SLB_TV	Slow blanking control signal to TV-scart		
STANDBY	Control signal from STI5505 used to swith off -5Vstby and +12Vstby during standby.		
STEREO_L	Audio cinch output left		
STEREO_R	Audio cinch output right		

■ IC DESCRIPTIONS

TZA1033

DVDALAS2plus Advanced Analog DVD Signal Processor and Laser Supply

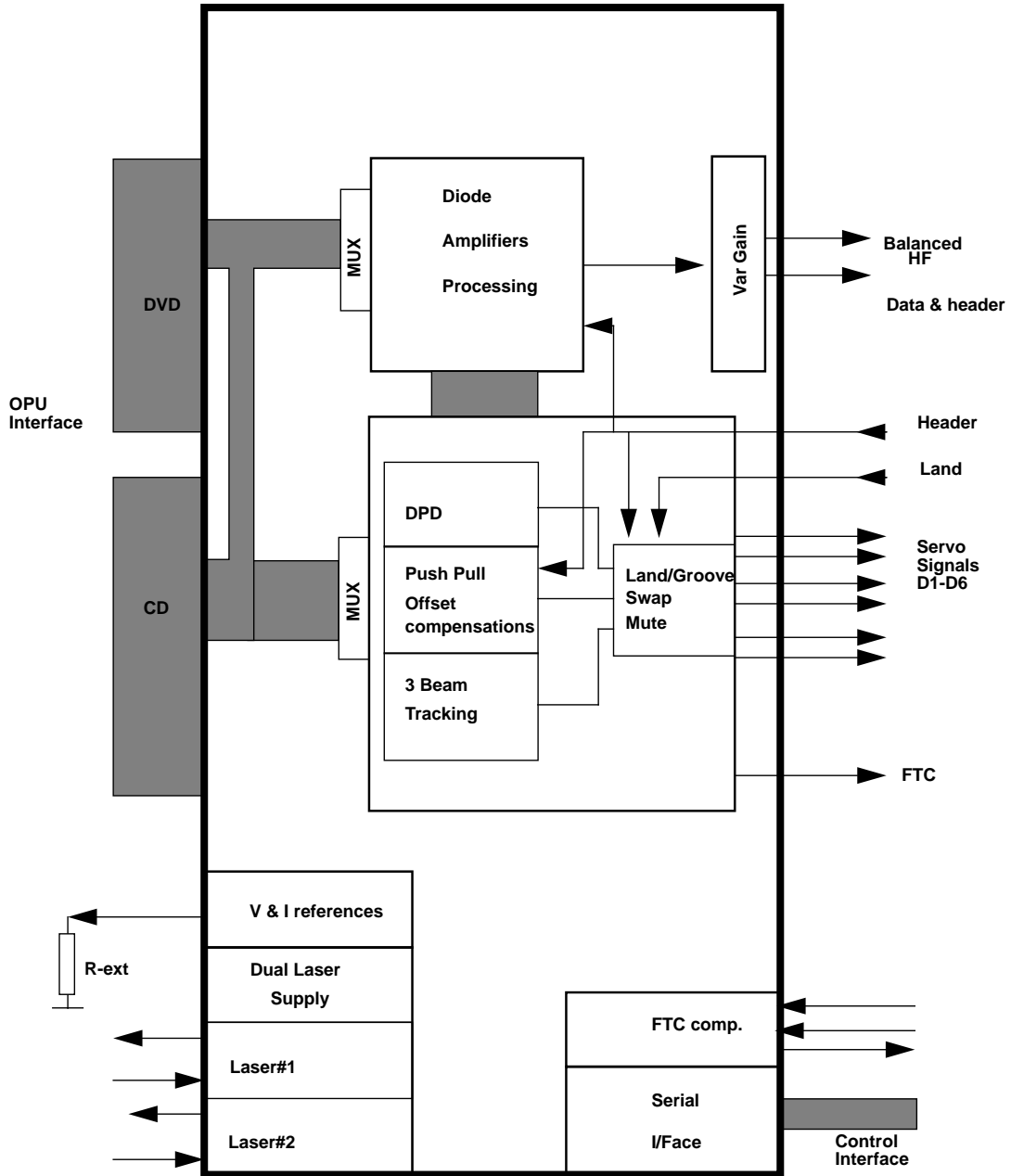

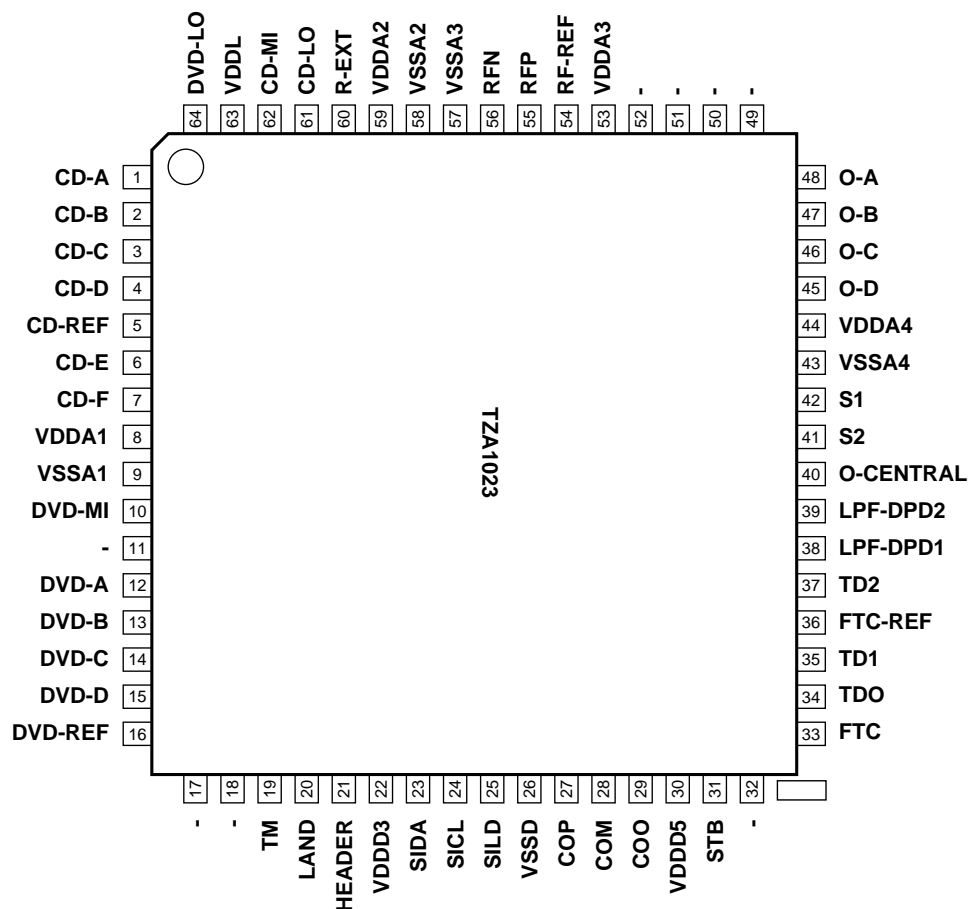
TZA1033**DVDALAS2plus Advanced Analog DVD Signal Processor and Laser Supply****Pin description**

Name	Pin	Description
CD-A	1	CD pick up input A
CD-B	2	CD pick up input B
CD-C	3	CD pick up input C
CD-D	4	CD pick up input D
CD-REF	5	CD pick up reference voltage
CD-E	6	CD pick up input E
CD-F	7	CD pick up input F
DVD-A	12	DVD pick up input A
DVD-B	13	DVD pick up input B
DVD-C	14	DVD pick up input C
DVD-D	15	DVD pick up input D
DVD-ref	16	DVD pick up reference voltage
O-A	48	Servo current output for Focus-A
O-B	47	Servo current output for Focus-B
O-C	46	Servo current output for Focus-C
O-D	45	Servo current output for Focus-D

TZA1033**DVDALAS2plus Advanced Analog DVD Signal Processor and Laser Supply**

Name	Pin	Description
O-central	40	Test pin for offset cancelation
TD2	37	Internally connected
FTC-ref	36	Servo output voltage reference input
S1	42	Servo current output for radial tracking
S2	41	Servo current output for radial tracking
TD1	35	Internally connected
FTC	33	Fast track count voltage output
RFP	55	pos. RF output signal
RFN	56	neg. RF output signal
RF-REF	54	DC Reference signal input RF
LPF-DPD1	38	DPD Low pass bandwidth capacitor, channel pos
LPF-DPD2	39	DPD Low pass bandwidth capacitor, channel neg
Land	20	Land/groove toggle input
HEADER	21	Header detector window input
CD-MI	62	CD laser monitor input
DVD-MI	10	DVD laser monitor input
CD-LO	61	CD laser output
DVD-LO	64	DVD laser output
COP	27	Positive input FTC comparator
COM	28	Inverting input FTC comparator
COO	29	FTC comparator output
SIDA	23	Serial host interface data input
SICL	24	Serial host interface clock input
SILD	25	Serial host interface load
VDDA1	8	Analog Supply voltage 1 (RF input)
VDDA2	59	Analog Supply voltage 2 (RF internal)
VDDA3	53	Analog Supply voltage 3 (RF output stage)
VDDA4	44	Analog Supply voltage 4 (Servo)
VDDD5	30	Digital Supply voltage (5V dig core)
VDDD3	22	Digital Supply voltage (3V I/O pads and FTC comp.)
VDDL	63	Supply voltage for laser
VSSA1	9	Analog Ground 1
VSSA2	58	Analog Ground 2
VSSA3	57	Analog Ground 3
VSSA4	43	Analog Ground 4
VSSD	26	Digital ground
R-EXT	60	Reference current input (Connect 12k1 to VSSA4)
STB	31	Standby input
TM	19	Test mode input
TDO	34	Test data out

BA6856FP

3 Phase motor driver for DVD players

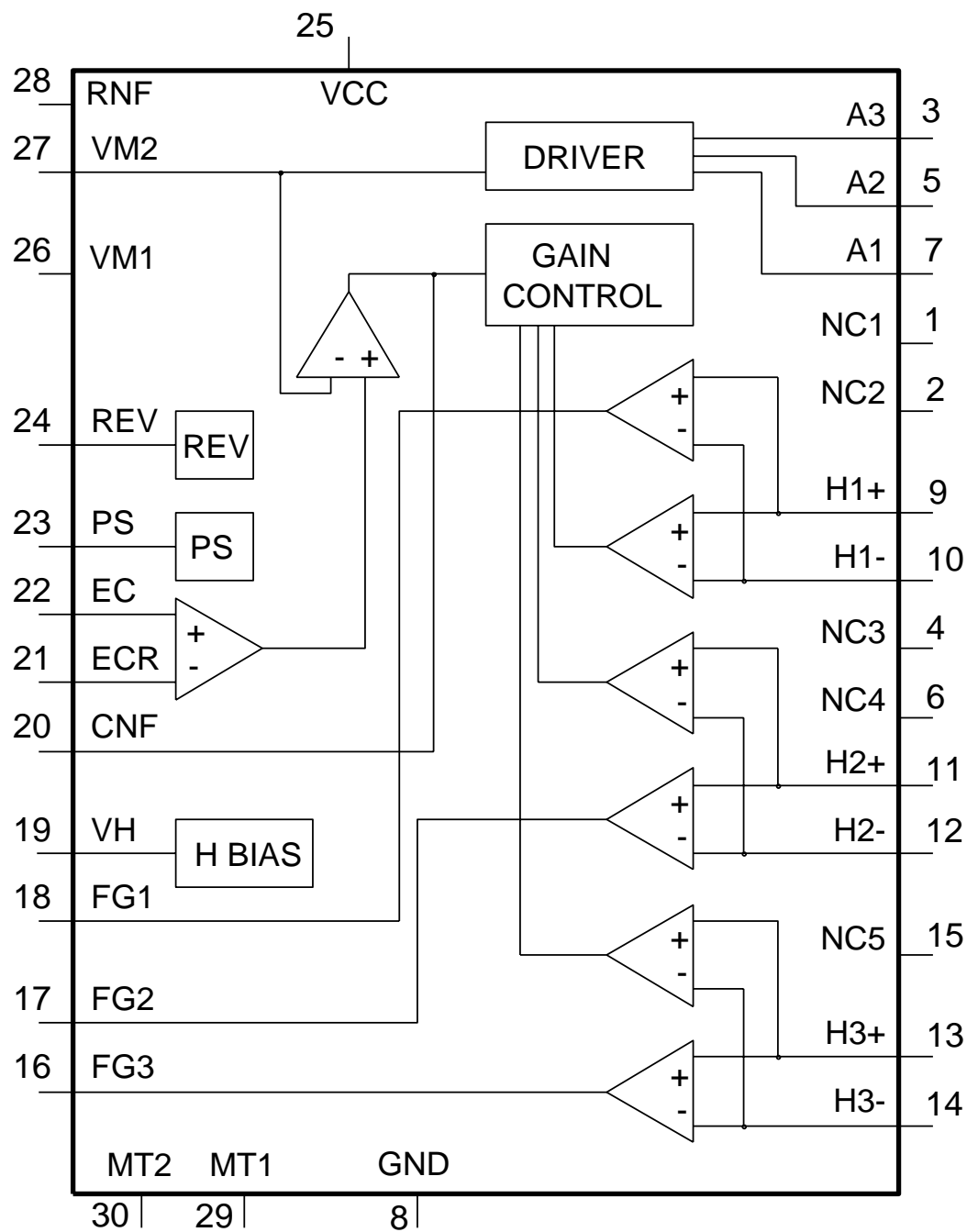

BA6856FP**3 Phase motor driver for DVD players****Pin description**

PIN No	PIN NAME	DESCRIPTION
1	N.C.	Not connected
2	N.C.	Not connected
3	A3	Output 3 for motor
4	N.C.	Not connected
5	A2	Output 2 for motor
6	N.C.	Not connected
7	A1	Output 1 for motor
8	GND	Ground
9	H1+	Hall input Amp1. positive input
10	H1-	Hall input Amp1. negative input
11	H2+	Hall input Amp2. positive input
12	H2-	Hall input Amp2. negative input
13	H3+	Hall input Amp3. positive input
14	H3-	Hall input Amp3. negative input
15	N.C.	Not connected
16	FG3	FG3 signal output terminal
17	FG2	FG2 signal output terminal
18	FG1	FG1 signal output terminal
19	VH	Hall Bias
20	CNF	Capacitor connection pin for phase compensation
21	ECR	Torque control standard voltage input terminal
22	EC	Torque control voltage input terminal
23	PS	POWER SAVE switch
24	REV	Reverse terminal
25	VCC	Power supply for signal division
26	VM2	Power supply 2 for driver
27	VM1	Power supply 2 for driver
28	RNF	Power supply for driver division

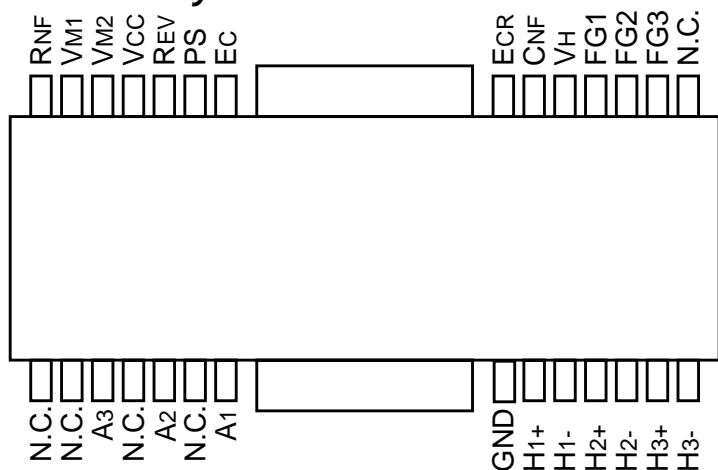
Terminal lay-out

SAA7335

DSP for CD and DVD-ROM system

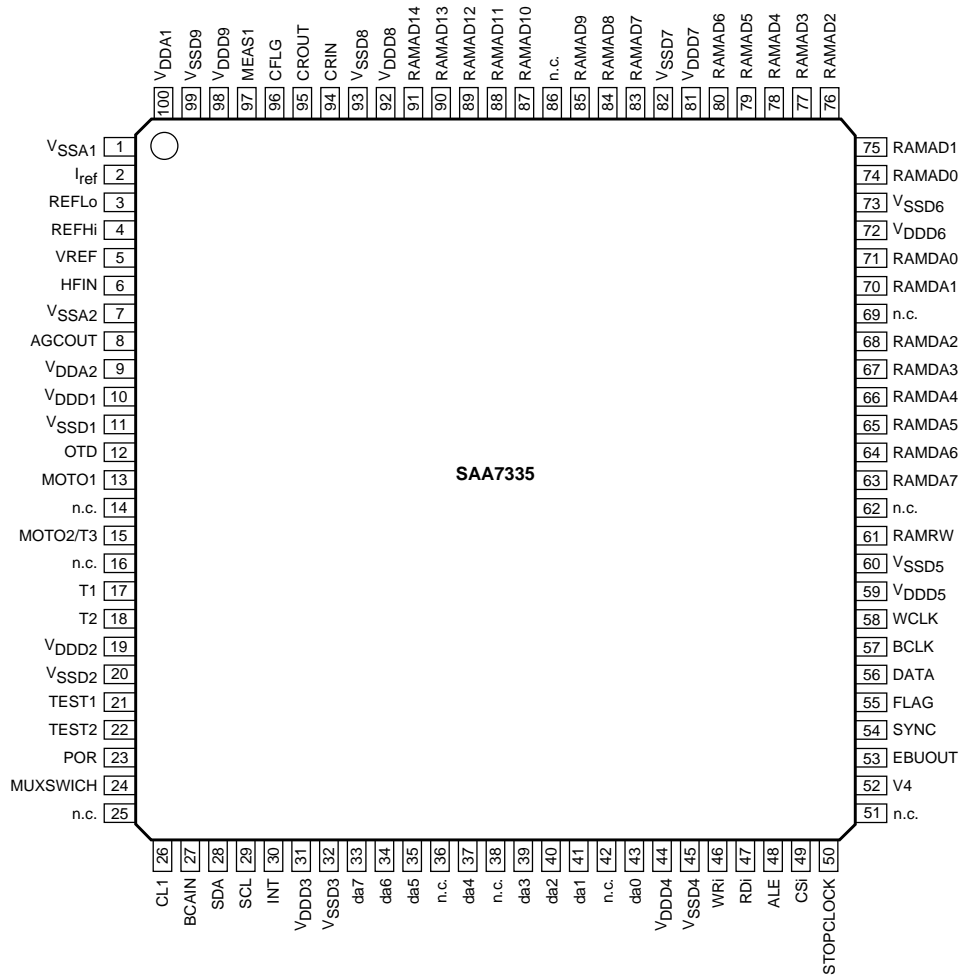
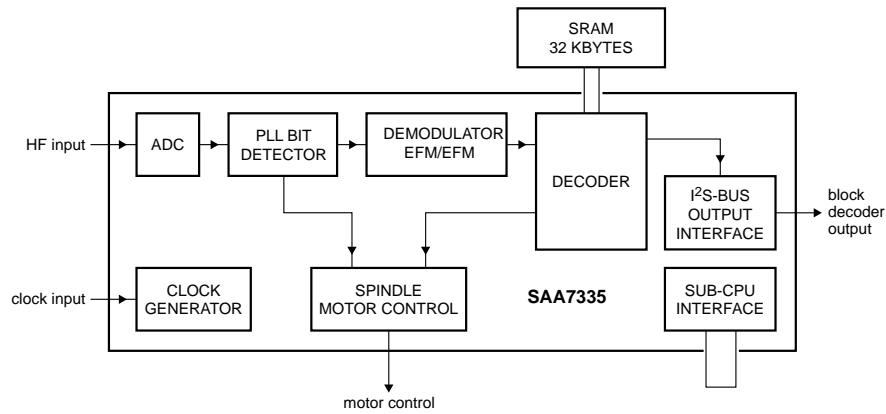

SAA7335**DSP for CD and DVD-ROM system****Pin description**

SYMBOL	PIN	TYPE	DESCRIPTION
VSSA1	1	supply	analog ground 1
Iref	2	I	analog current reference input for ADC
REFLo	3	I	analog low reference input for ADC
REFHi	4	I	analog high reference input for ADC
VREF	5	I	analog negative input
HFIN	6	I	analog positive input
VSSA2	7	supply	analog ground 2
AGCOUT	8	O	analog test pin output
VDDA2	9	supply	analog supply voltage 2
VDDD1	10	supply	digital supply voltage 1
VSSD1	11	supply	digital ground 1
OTD	12	I	off track detect input
MOTO1	13	O	3-state motor control output
n.c.	14	–	not connected, reserved
MOTO2/T3	15	I/O	motor control output/tachometer 3 input
n.c.	16	–	not connected, reserved
T1	17	I	tachometer 1 input
T2	18	I	tachometer 2 input
VDDD2	19	supply	digital supply voltage 2
VSSD2	20	supply	digital ground 2
TEST1	21	I	test input 1
TEST2	22	I	test input 2
POR	23	I	power-on reset input
MUXSWICH	24	I	use clock multiplier input
n.c.	25	–	not connected, reserved
CL1	26	O	divided clock output
BCAIN	27	I	BCA input
SDA	28	I/O	sub-CPU I 2 C-bus serial data input/output
SCL	29	I	sub-CPU I 2 C-bus serial clock input
INT	30	O	sub-CPU interrupt output (open-drain)
VDDD3	31	supply	digital supply voltage 3
VSSD3	32	supply	digital ground 3
da7	33	I/O	sub-CPU data bus bit 7 input/output (parallel)
da6	34	I/O	sub-CPU data bus bit 6 input/output (parallel)
da5	35	I/O	sub-CPU data bus bit 5 input/output (parallel)
n.c.	36	–	not connected, reserved
da4	37	I/O	sub-CPU data bus bit 4 input/output (parallel)
n.c.	38	–	not connected, reserved
da3	39	I/O	sub-CPU data bus bit 3 input/output (parallel)
da2	40	I/O	sub-CPU data bus bit 2 input/output (parallel)
da1	41	I/O	sub-CPU data bus bit 1 input/output (parallel)
n.c.	42	–	not connected, reserved
da0	43	I/O	sub-CPU data bus bit 0 input/output (parallel)
VDDD4	44	supply	digital supply voltage 4
VSSD4	45	supply	digital ground 4
WRi	46	I	sub-CPU write enable input (active LOW)
RDi	47	I	sub-CPU read enable input (active LOW)
ALE	48	I	sub-CPU address latch enable input
CSi	49	I	sub-CPU chip select input (active HIGH)
STOPCLOCK	50	O	stop clock output

SAA7335**DSP for CD and DVD-ROM system**

SYMBOL	PIN	TYPE	DESCRIPTION
n.c.	51	–	not connected, reserved
V4	52	O	serial subcode output (for CD)
EBUOUT	53	O	digital audio output
SYNC	54	O	I ² S-bus sector sync output
FLAG	55	O	I ² S-bus correction flag output
DATA	56	O	I ² S-bus serial data output
BCLK	57	I/O	I ² S-bus bit serial clock input/output
WCLK	58	I/O	I ² S-bus word clock input/output
VDDD5	59	supply	digital supply voltage 5
VSSD5	60	supply	digital ground 5
RAMRW	61	O	RAM read/write control output
n.c.	62	–	not connected, reserved
RAMDA7	63	I/O	RAM data bus bit 7 input/output
RAMDA6	64	I/O	RAM data bus bit 6 input/output
RAMDA5	65	I/O	RAM data bus bit 5 input/output
RAMDA4	66	I/O	RAM data bus bit 4 input/output
RAMDA3	67	I/O	RAM data bus bit 3 input/output
RAMDA2	68	I/O	RAM data bus bit 2 input/output
n.c.	69	–	not connected, reserved
RAMDA1	70	I/O	RAM data bus bit 1 input/output
RAMDA0	71	I/O	RAM data bus bit 0 input/output
VDDD6	72	supply	digital supply voltage 6
VSSD6	73	supply	digital ground 6
RAMAD0	74	O	RAM address bit 0 output
RAMAD1	75	O	RAM address bit 1 output
RAMAD2	76	O	RAM address bit 2 output
RAMAD3	77	O	RAM address bit 3 output
RAMAD4	78	O	RAM address bit 4 output
RAMAD5	79	O	RAM address bit 5 output
RAMAD6	80	O	RAM address bit 6 output
VDDD7	81	supply	digital supply voltage 7
VSSD7	82	supply	digital ground 7
RAMAD7	83	O	RAM address bit 7 output
RAMAD8	84	O	RAM address bit 8 output
RAMAD9	85	O	RAM address bit 9 output
n.c.	86	–	not connected, reserved
RAMAD10	87	O	RAM address bit 10 output
RAMAD11	88	O	RAM address bit 11 output
RAMAD12	89	O	RAM address bit 12 output
RAMAD13	90	O	RAM address bit 13 output
RAMAD14	91	O	RAM address bit 14 output
VDDD8	92	supply	digital supply voltage 8
VSSD8	93	supply	digital ground 8
CRIN	94	I	analog crystal input
CROUT	95	O	analog crystal output
CFLG	96	O	correction statistics output
MEAS1	97	O	front-end telemetry output
VDDD9	98	supply	digital supply voltage 9
VSSD9	99	supply	digital ground 9
VDDA1	100	supply	analog supply voltage 1

Am29LV160B

16 MB (2 M x 8-bit / 1 M x 16-bit) CMOS 3.0 Volt-only Sector Erase Flash Memory

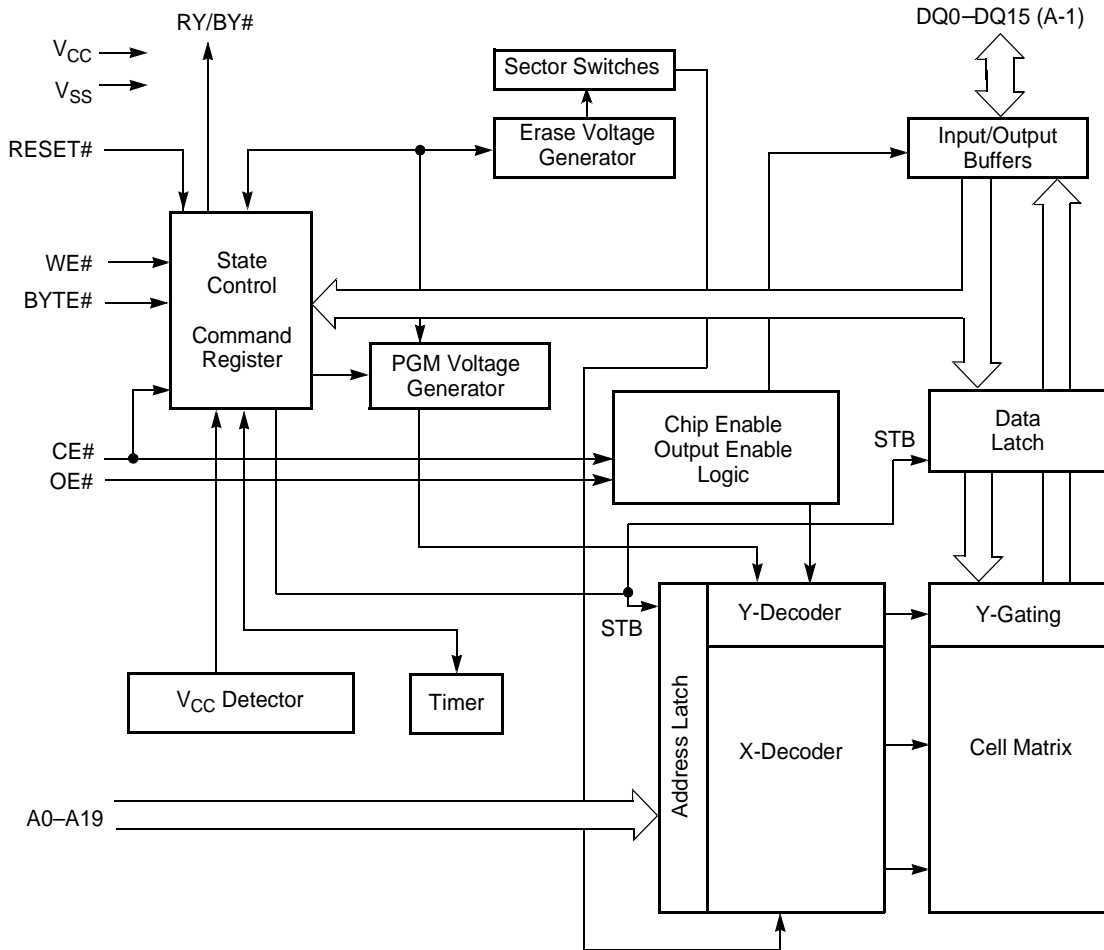

MT48LC1M16A1TG S

Synchronous DRAM

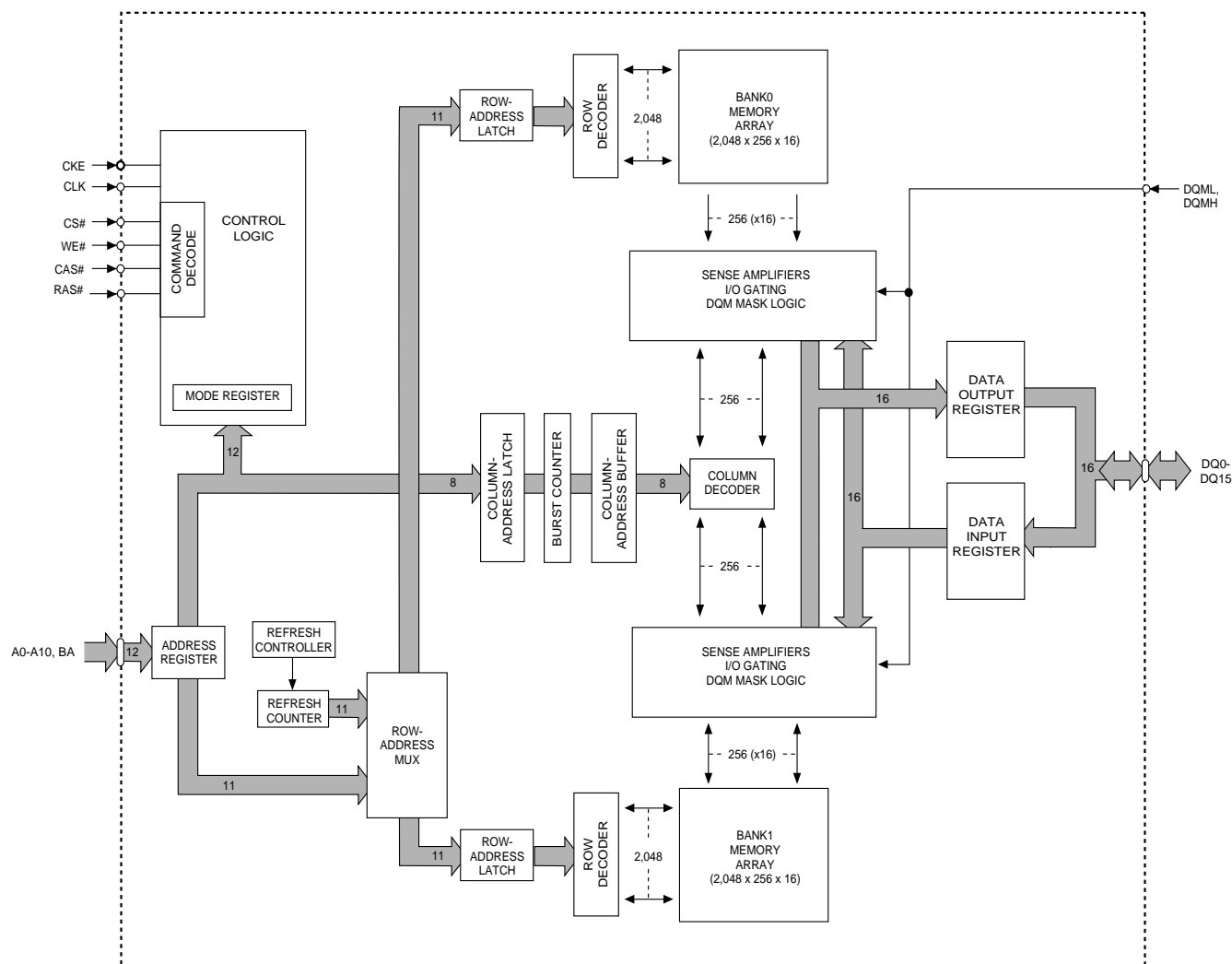
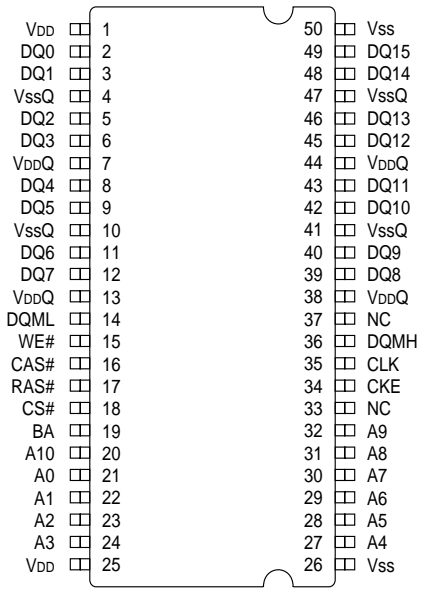

1 ■ WIRING DIAGRAM

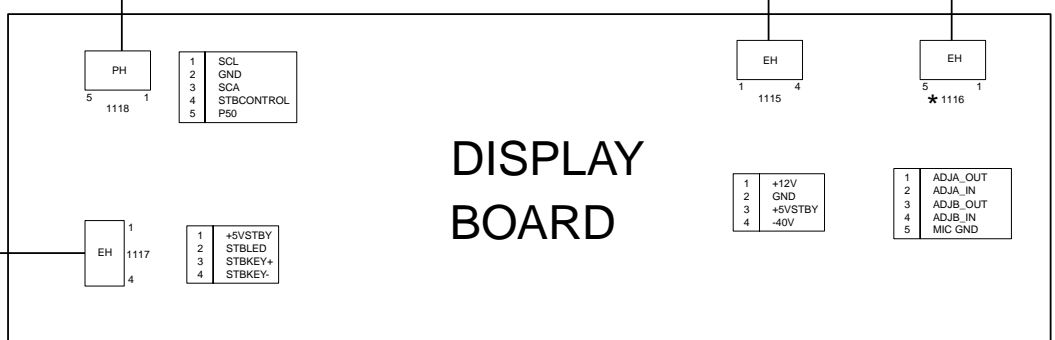
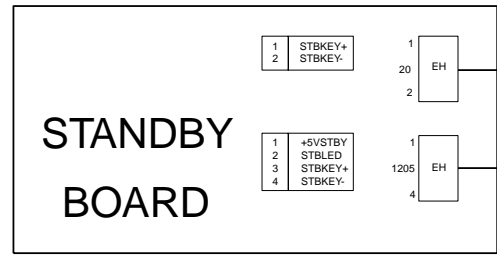
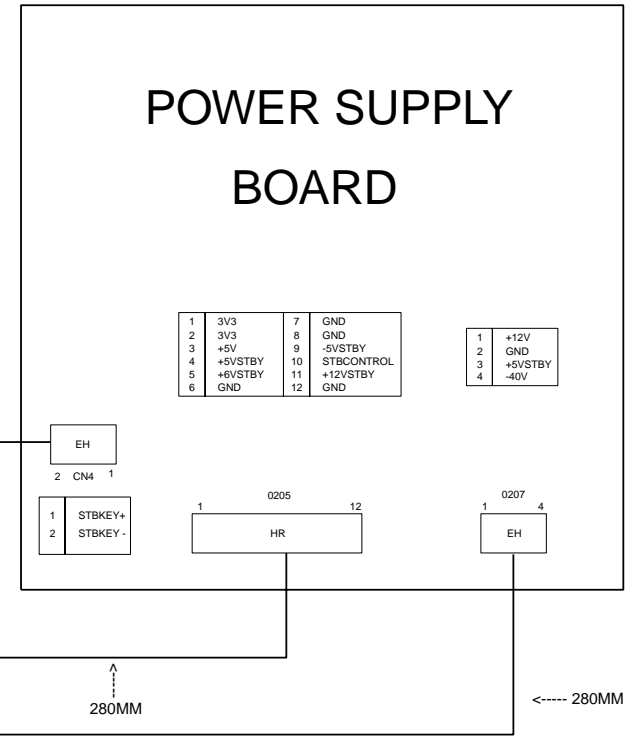
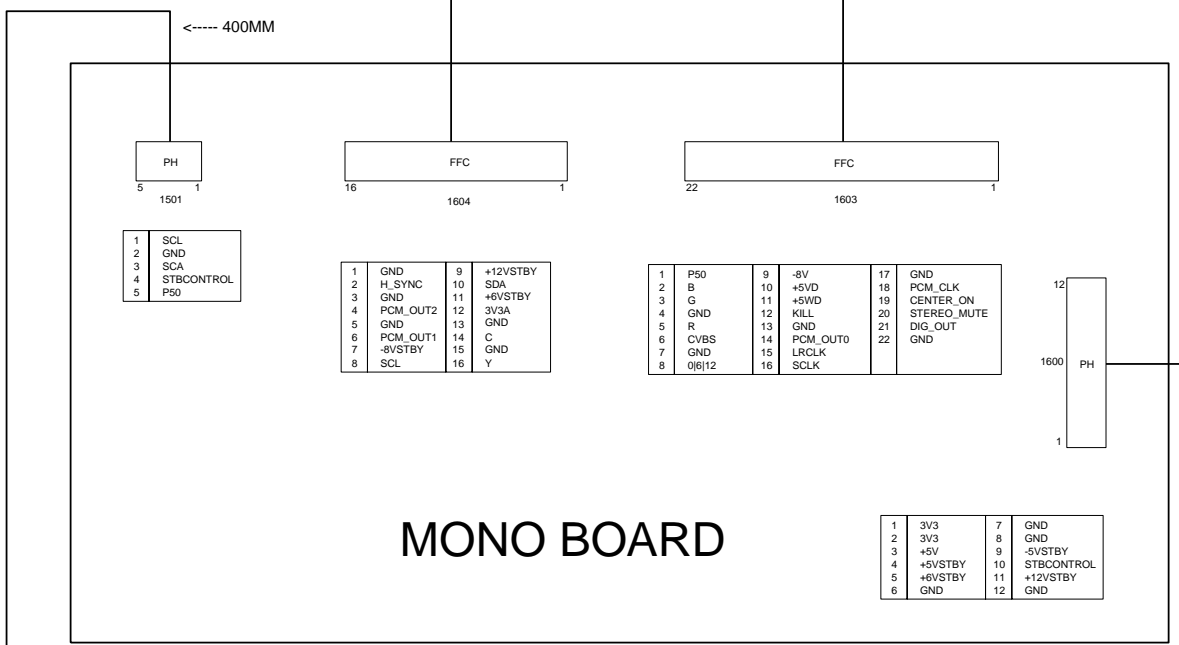
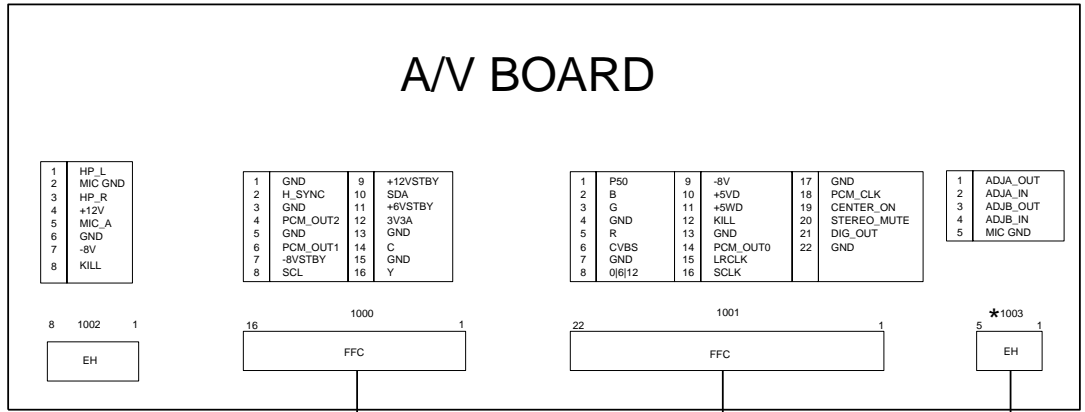

■ BLOCK DIAGRAM (U, C, A, R, T)

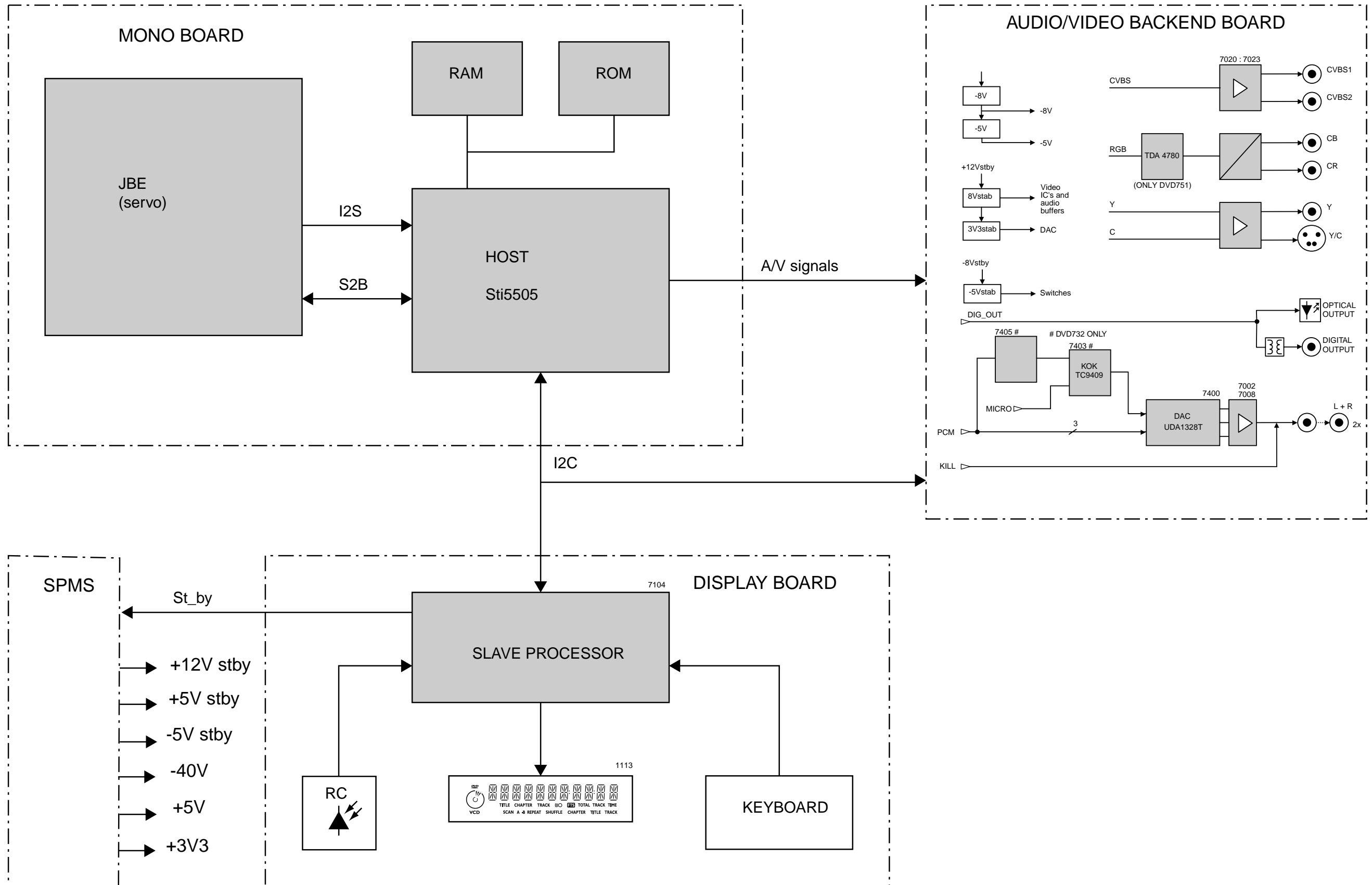

1 ■ BLOCK DIAGRAM (B, G)

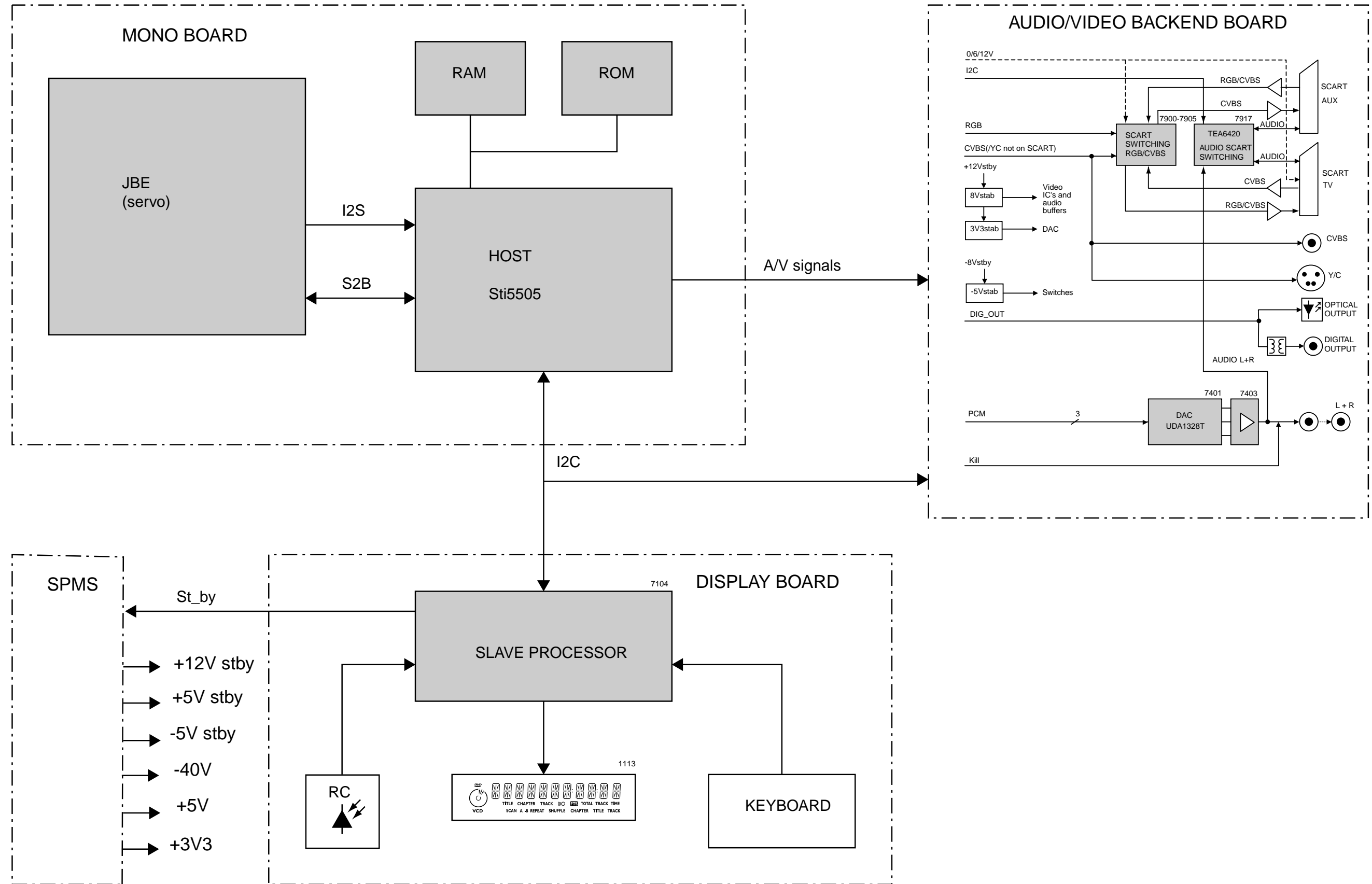

■ PRINTED CIRCUIT BOARD
MONO (Detailed bottom view 1/2)

1
2
3
4
5
6
7

A

B

A

B

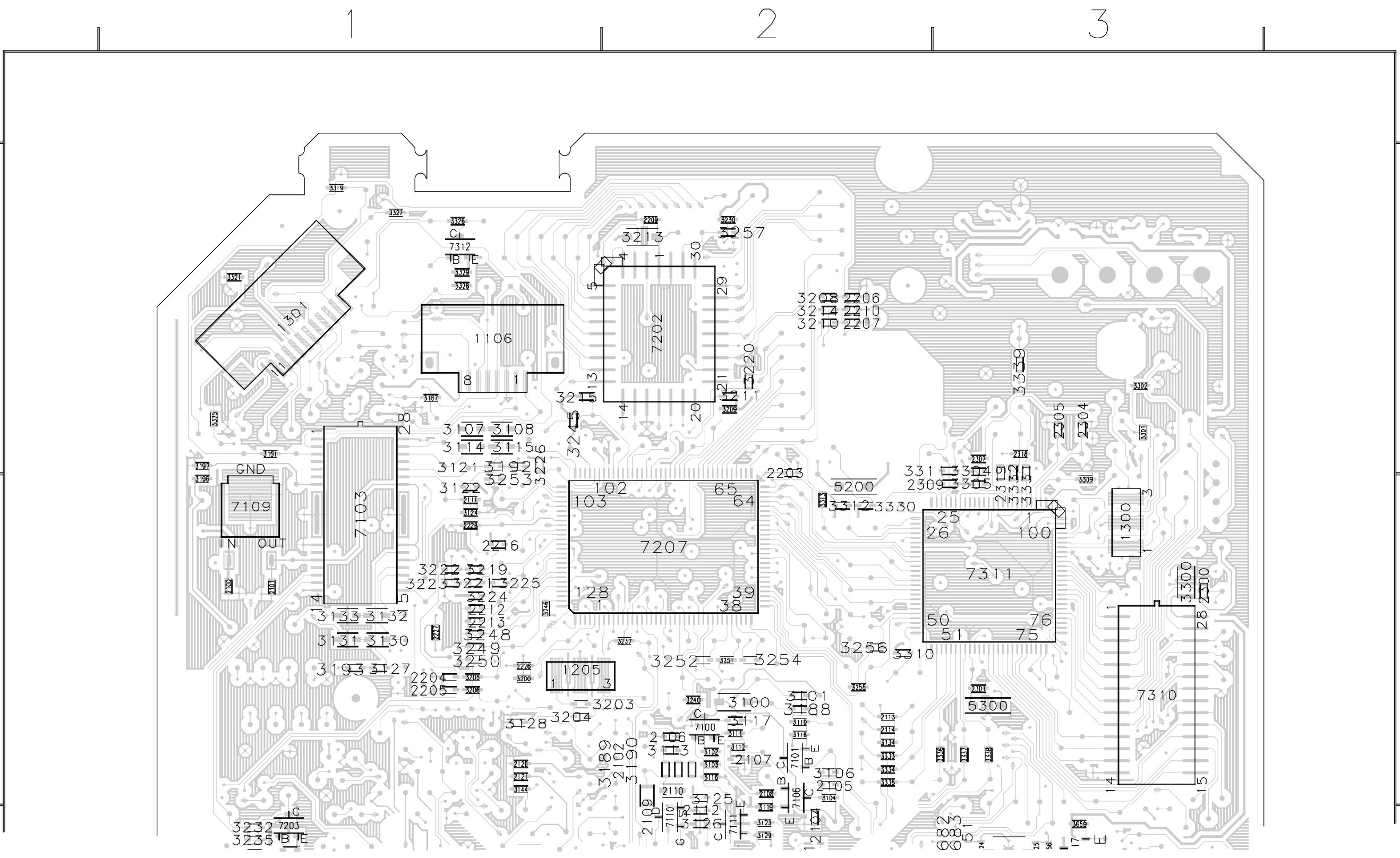

1

PRINTED CIRCUIT BOARD

MONO (Detailed top view 2/2)

2

3

4

5

6

7

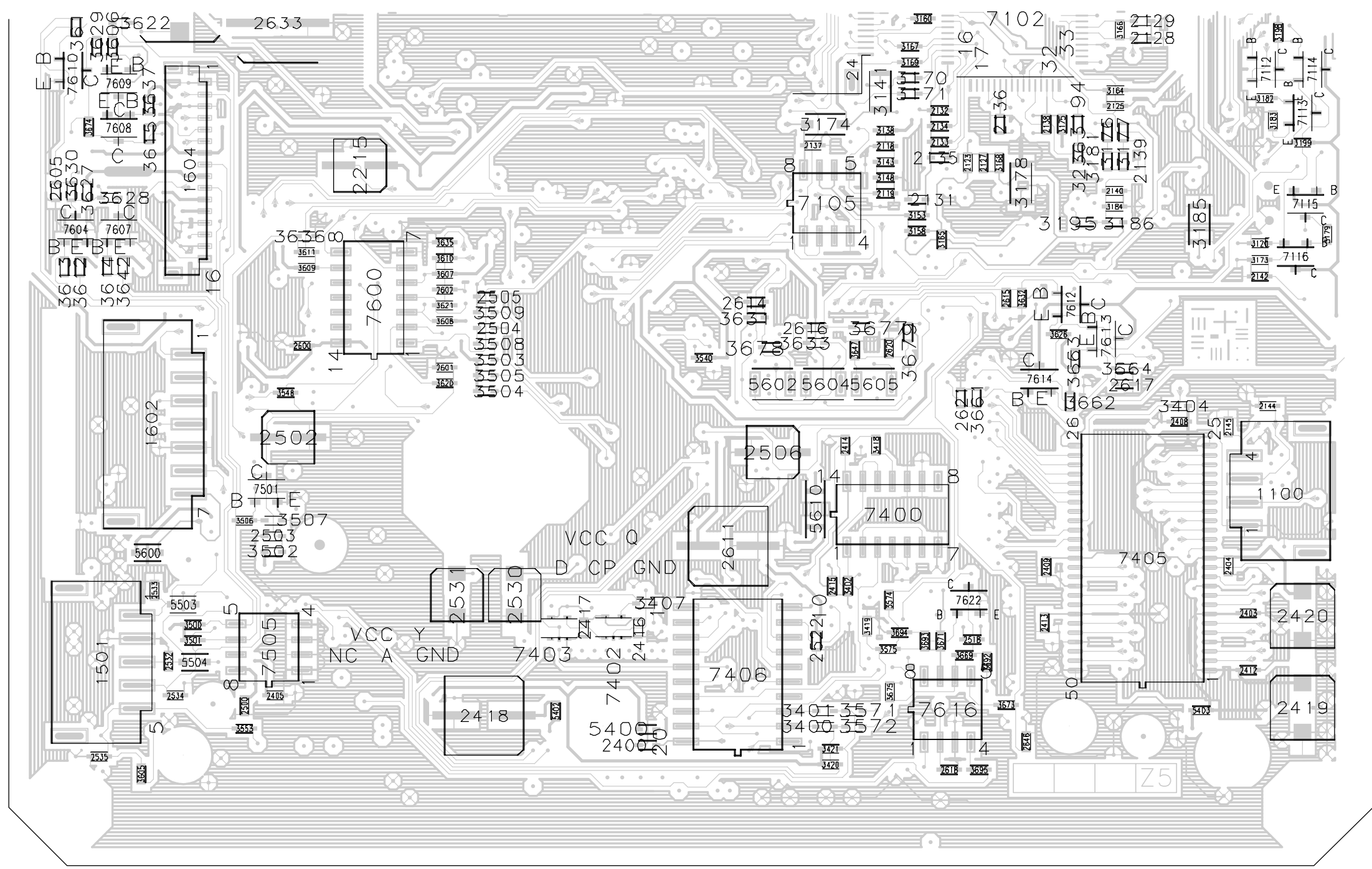

PRINTED CIRCUIT BOARD

A/V (U, C, A, R, T)

1000 A6	1008 C6	2004 B7	2202 A5	2207 A5	2216 B2	3037 B8	3205 B5	5004 C8	5008 C4	9000 A4	9004 A4	9010 B8	9014 A10	TF00 C6
1001 B4	1011 C6	2008 B10	2203 C5	2210 A4	2225 C4	3038 A11	3224 C5	5005 C10	7002 A1	9001 A4	9005 B5	9012 A8	9016 A8	TF01 C7
1003 C1	2001 A2	2016 A11	2204 B8	2214 B6	2231 B1	3040 B11	3225 C5	5006 C9	7010 B2	9002 B3	9006 B5	9013 A9	9017 A10	TF02 C6
1006 C9	2002 A3	2200 A7	2205 B4	2215 B7	3033 B11	3049 B9	5003 C7	5007 C8	7028 C4	9003 B4	9008 A7	9013 A9	9102 A9	

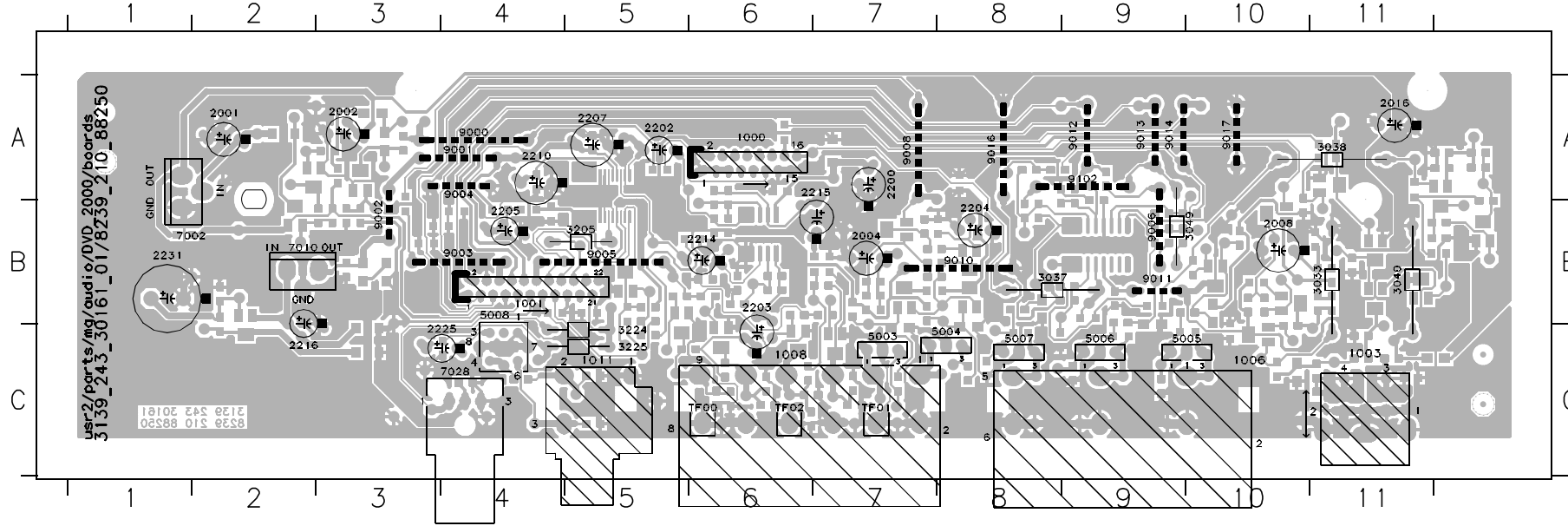

2007 C2	2211 A	3000 A10	3011 C5	3020 C5	3024 B2	3044 B4	3057 B4	3230 C10	4011 B	4017 B	4020 B	4030 B	4033 B	4034 B	4035 B	4036 B	4037 B	4038 B	4039 B	4040 B	4041 B	4042 B	4043 B	4044 B	4045 B	4046 B	4047 B	4048 B	4049 B	4050 B	4051 B	4052 B	4053 B	4054 B	4055 B	4056 B	4057 B	4058 B	4059 B	4060 B	4061 B	4062 B	4063 B	4064 B	4065 B	4066 B	4067 B	4068 B	4069 B	4070 B	4071 B	4072 B	4073 B	4074 B	4075 B	4076 B	4077 B	4078 B	4079 B	4080 B	4081 B	4082 B	4083 B	4084 B	4085 B	4086 B	4087 B	4088 B	4089 B	4090 B	4091 B	4092 B	4093 B	4094 B	4095 B	4096 B	4097 B	4098 B	4099 B	4100 B	4101 B	4102 B	4103 B	4104 B	4105 B	4106 B	4107 B	4108 B	4109 B	4110 B	4111 B	4112 B	4113 B	4114 B	4115 B	4116 B	4117 B	4118 B	4119 B	4120 B	4121 B	4122 B	4123 B	4124 B	4125 B	4126 B	4127 B	4128 B	4129 B	4130 B	4131 B	4132 B	4133 B	4134 B	4135 B	4136 B	4137 B	4138 B	4139 B	4140 B	4141 B	4142 B	4143 B	4144 B	4145 B	4146 B	4147 B	4148 B	4149 B	4150 B	4151 B	4152 B	4153 B	4154 B	4155 B	4156 B	4157 B	4158 B	4159 B	4160 B	4161 B	4162 B	4163 B	4164 B	4165 B	4166 B	4167 B	4168 B	4169 B	4170 B	4171 B	4172 B	4173 B	4174 B	4175 B	4176 B	4177 B	4178 B	4179 B	4180 B	4181 B	4182 B	4183 B	4184 B	4185 B	4186 B	4187 B	4188 B	4189 B	4190 B	4191 B	4192 B	4193 B	4194 B	4195 B	4196 B	4197 B	4198 B	4199 B	4200 B	4201 B	4202 B	4203 B	4204 B	4205 B	4206 B	4207 B	4208 B	4209 B	4210 B	4211 B	4212 B	4213 B	4214 B	4215 B	4216 B	4217 B	4218 B	4219 B	4220 B	4221 B	4222 B	4223 B	4224 B	4225 B	4226 B	4227 B	4228 B	4229 B	4230 B	4231 B	4232 B	4233 B	4234 B	4235 B	4236 B	4237 B	4238 B	4239 B	4240 B	4241 B	4242 B	4243 B	4244 B	4245 B	4246 B	4247 B	4248 B	4249 B	4250 B	4251 B	4252 B	4253 B	4254 B	4255 B	4256 B	4257 B	4258 B	4259 B	4260 B	4261 B	4262 B	4263 B	4264 B	4265 B	4266 B	4267 B	4268 B	4269 B	4270 B	4271 B	4272 B	4273 B	4274 B	4275 B	4276 B	4277 B	4278 B	4279 B	4280 B	4281 B	4282 B	4283 B	4284 B	4285 B	4286 B	4287 B	4288 B	4289 B	4290 B	4291 B	4292 B	4293 B	4294 B	4295 B	4296 B	4297 B	4298 B	4299 B	4300 B	4301 B	4302 B	4303 B	4304 B	4305 B	4306 B	4307 B	4308 B	4309 B	4310 B	4311 B	4312 B	4313 B	4314 B	4315 B	4316 B	4317 B	4318 B	4319 B	4320 B	4321 B	4322 B	4323 B	4324 B	4325 B	4326 B	4327 B	4328 B	4329 B	4330 B	4331 B	4332 B	4333 B	4334 B	4335 B	4336 B	4337 B	4338 B	4339 B	4340 B	4341 B	4342 B	4343 B	4344 B	4345 B	4346 B	4347 B	4348 B	4349 B	4350 B	4351 B	4352 B	4353 B	4354 B	4355 B	4356 B	4357 B	4358 B	4359 B	4360 B	4361 B	4362 B	4363 B	4364 B	4365 B	4366 B	4367 B	4368 B	4369 B	4370 B	4371 B	4372 B	4373 B	4374 B	4375 B	4376 B	4377 B	4378 B	4379 B	4380 B	4381 B	4382 B	4383 B	4384 B	4385 B	4386 B	4387 B	4388 B	4389 B	4390 B	4391 B	4392 B	4393 B	4394 B	4395 B	4396 B	4397 B	4398 B	4399 B	4400 B	4401 B	4402 B	4403 B	4404 B	4405 B	4406 B	4407 B	4408 B	4409 B	4410 B	4411 B	4412 B	4413 B	4414 B	4415 B	4416 B	4417 B	4418 B	4419 B	4420 B	4421 B	4422 B	4423 B	4424 B	4425 B	4426 B	4427 B	4428 B	4429 B	4430 B	4431 B	4432 B	4433 B	4434 B	4435 B	4436 B	4437 B	4438 B	4439 B	4440 B	4441 B	4442 B	4443 B	4444 B	4445 B	4446 B	4447 B	4448 B	4449 B	4450 B	4451 B	4452 B	4453 B	4454 B	4455 B	4456 B	4457 B	4458 B	4459 B	4460 B	4461 B	4462 B	4463 B	4464 B	4465 B	4466 B	4467 B	4468 B	4469 B	4470 B	4471 B	4472 B	4473 B	4474 B	4475 B	4476 B	4477 B	4478 B	4479 B	4480 B	4481 B	4482 B	4483 B	4484 B	4485 B	4486 B	4487 B	4488 B	4489 B	4490 B	4491 B	4492 B	4493 B	4494 B	4495 B	4496 B	4497 B	4498 B	4499 B	4500 B	4501 B	4502 B	4503 B	4504 B	4505 B	4506 B	4507 B	4508 B	4509 B	4510 B	4511 B	4512 B	4513 B	4514 B	4515 B	4516 B	4517 B	4518 B	4519 B	4520 B	4521 B	4522 B	4523 B	4524 B	4525 B	4526 B	4527 B	4528 B	4529 B	4530 B	4531 B	4532 B	4533 B	4534 B	4535 B	4536 B	4537 B	4538 B	4539 B	4540 B	4541 B	4542 B	4543 B	4544 B	4545 B	4546 B	4547 B	4548 B	4549 B	4550 B	4551 B	4552 B	4553 B	4554 B	4555 B	4556 B	4557 B	4558 B	4559 B	4560 B	4561 B	4562 B	4563 B	4564 B	4565 B	4566 B	4567 B	4568 B	4569 B	4570 B	4571 B	4572 B	4573 B	4574 B	4575 B	4576 B	4577 B	4578 B	4579 B	4580 B	4581 B	4582 B	4583 B	4584 B	4585 B	4586 B	4587 B	4588 B	4589 B	4590 B	4591 B	4592 B	4593 B	4594 B	4595 B	4596 B	4597 B	4598 B	4599 B	4600 B	4601 B	4602 B	4603 B	4604 B	4605 B	4606 B	4607 B	4608 B	4609 B	4610 B	4611 B	4612 B	4613 B	4614 B	4615 B	4616 B	4617 B	4618 B	4619 B	4620 B	4621 B	4622 B	4623 B	4624 B	4625 B	4626 B	4627 B	4628 B	4629 B	4630 B	4631 B	4632 B	4633 B	4634 B	4635 B	4636 B	4637 B	4638 B	4639 B	4640 B	4641 B	4642 B	4643 B	4644 B	4645 B	4646 B	4647 B	4648 B	4649 B	4650 B	4651 B	4652 B	4653 B	4654 B	4655 B	4656 B	4657 B	4658 B	4659 B	4660 B	4661 B	4662 B	4663 B	4664 B	4665 B	4666 B	4667 B	4668 B	4669 B	4670 B	4671 B	4672 B	4673 B	4674 B	4675 B	4676 B	4677 B	4678 B	4679 B	4680 B	4681 B	4682 B	4683 B	4684 B	4685 B	4686 B	4687 B	4688 B	4689 B	4690 B	4691 B	4692 B	4693 B	4694 B	4695 B	4696 B	4697 B	4698 B	4699 B	4700 B	4701 B	4702 B	4703 B	4704 B	4705 B	4706 B	4707 B	4708 B	4709 B	4710 B	4711 B	4712 B	4713 B	4714 B	4715 B	4716 B	4717 B	4718 B	4719 B	4720 B	4721 B	4722 B	4723 B	4724 B	4725 B	4726 B	4727 B	4728 B	4729 B	4730 B	4731 B	4732 B	4733 B	4734 B	4735 B	4736 B	4737 B	4738 B	4739 B	4740 B	4741 B	4742 B	4743 B	4744 B	4745 B	4746 B	4747 B	4748 B	4749 B	4750 B	4751 B	4752 B	4753 B	4754 B	4755 B	4756 B	4757 B	4758 B	4759 B	4760 B	4761 B	4762 B	4763 B	4764 B	4765 B	4766 B	4767 B	4768 B	4769 B	4770 B	4771 B	4772 B	4773 B	4774 B	4775 B	4776 B	4777 B	4778 B	4779 B	4780 B	4781 B	4782 B	4783 B	4784 B	4785 B	4786 B	4787 B	4788 B	4789 B	4790 B	4791 B	4792 B	4793 B	4794 B	4795 B	4796 B	4797 B	4798 B	4799 B	4800 B	4801 B	4802 B	4803 B	4804 B	4805 B	4806 B	4807 B	4808 B	4809 B	4810 B	4811 B	4812 B	4813 B	4814 B	4815 B	4816 B	4817 B	4818 B	4819 B	4820 B	4821 B	4822 B	4823 B	4824 B	4825 B	4826 B	4827 B	4828 B	4829 B	4830 B	4831 B	4832 B	4833 B	4834 B	4835 B	4836 B	4837 B	4838 B	4839 B	4840 B	4841 B	4842 B	4843 B	4844 B	4845 B	4846 B	4847 B	4848 B	4849 B	4850 B	4851 B	4852 B	4853 B	4854 B	4855 B	4856 B	4857 B	4858 B	4859 B	4860 B	4861 B	4862 B	4863 B	4864 B	4865 B	4866 B	4867 B	4868 B	4869 B	4870 B	4871 B	4872 B	4873 B	4874 B	4875 B	4876 B	4877 B	4878 B	4879 B	4880 B	4881 B	4882 B	4883 B	4884 B	4885 B	4886 B	4887 B	4888 B	4889 B	4890 B	4891 B	4892 B	4893 B	4894 B	4895 B	4896 B	4897 B	4898 B	4899 B	4900 B	4901 B	4902 B	4903 B	4904 B	4905 B	4906 B	4907 B	4908 B	4909 B	4910 B	4911 B	4912 B	4913 B	4914 B	4915 B	4916 B	4917 B	4918 B	4919 B	4920 B	4921 B	4922 B	4923 B	4924 B	4925 B	4926 B	4927 B	4928 B	4929 B	4930 B	4931 B	4932 B	4933 B	4934 B	4935 B	4936 B	4937 B	4938 B	4939 B	4940 B	4941 B	4942 B	4943 B	4944 B	4945 B	4946 B	4947 B	4948 B	4949 B	4950 B	4951 B	4952 B	4953 B	4954 B	4955 B	4956 B	4957 B	4958 B	4959 B	4960 B	4961 B	4962 B	4963 B	4964 B	4965 B	4966 B	4967 B	4968 B	4969 B	4970 B	4971 B	4972 B	4973 B	4974 B	4975 B	4976 B	4977 B	4978 B	4979 B	4980 B	4981 B	4982 B	4983 B	4984 B	4985 B	4986 B	4987 B	4988 B	4989 B	4990 B	4991 B	4992 B	4993 B	4994 B	4995 B	4996 B	4997 B	4998 B	4999 B	5000 B
---------	--------	----------	---------	---------	---------	---------	---------	----------	--------	--------	--------	--------	--------	--------	--------	--------	--------	--------	--------	--------	--------	--------	--------	--------	--------	--------	--------	--------	--------	--------	--------	--------	--------	--------	--------	--------	--------	--------	--------	--------	--------	--------	--------	--------	--------	--------	--------	--------	--------	--------	--------	--------	--------	--------	--------	--------	--------	--------	--------	--------	--------	--------	--------	--------	--------	--------	--------	--------	--------	--------	--------	--------	--------	--------	--------	--------	--------	--------	--------	--------	--------	--------	--------	--------	--------	--------	--------	--------	--------	--------	--------	--------	--------	--------	--------	--------	--------	--------	--------	--------	--------	--------	--------	--------	--------	--------	--------	--------	--------	--------	--------	--------	--------	--------	--------	--------	--------	--------	--------	--------	--------	--------	--------	--------	--------	--------	--------	--------	--------	--------	--------	--------	--------	--------	--------	--------	--------	--------	--------	--------	--------	--------	--------	--------	--------	--------	--------	--------	--------	--------	--------	--------	--------	--------	--------	--------	--------	--------	--------	--------	--------	--------	--------	--------	--------	--------	--------	--------	--------	--------	--------	--------	--------	--------	--------	--------	--------	--------	--------	--------	--------	--------	--------	--------	--------	--------	--------	--------	--------	--------	--------	--------	--------	--------	--------	--------	--------	--------	--------	--------	--------	--------	--------	--------	--------	--------	--------	--------	--------	--------	--------	--------	--------	--------	--------	--------	--------	--------	--------	--------	--------	--------	--------	--------	--------	--------	--------	--------	--------	--------	--------	--------	--------	--------	--------	--------	--------	--------	--------	--------	--------	--------	--------	--------	--------	--------	--------	--------	--------	--------	--------	--------	--------	--------	--------	--------	--------	--------	--------	--------	--------	--------	--------	--------	--------	--------	--------	--------	--------	--------	--------	--------	--------	--------	--------	--------	--------	--------	--------	--------	--------	--------	--------	--------	--------	--------	--------	--------	--------	--------	--------	--------	--------	--------	--------	--------	--------	--------	--------	--------	--------	--------	--------	--------	--------	--------	--------	--------	--------	--------	--------	--------	--------	--------	--------	--------	--------	--------	--------	--------	--------	--------	--------	--------	--------	--------	--------	--------	--------	--------	--------	--------	--------	--------	--------	--------	--------	--------	--------	--------	--------	--------	--------	--------	--------	--------	--------	--------	--------	--------	--------	--------	--------	--------	--------	--------	--------	--------	--------	--------	--------	--------	--------	--------	--------	--------	--------	--------	--------	--------	--------	--------	--------	--------	--------	--------	--------	--------	--------	--------	--------	--------	--------	--------	--------	--------	--------	--------	--------	--------	--------	--------	--------	--------	--------	--------	--------	--------	--------	--------	--------	--------	--------	--------	--------	--------	--------	--------	--------	--------	--------	--------	--------	--------	--------	--------	--------	--------	--------	--------	--------	--------	--------	--------	--------	--------	--------	--------	--------	--------	--------	--------	--------	--------	--------	--------	--------	--------	--------	--------	--------	--------	--------	--------	--------	--------	--------	--------	--------	--------	--------	--------	--------	--------	--------	--------	--------	--------	--------	--------	--------	--------	--------	--------	--------	--------	--------	--------	--------	--------	--------	--------	--------	--------	--------	--------	--------	--------	--------	--------	--------	--------	--------	--------	--------	--------	--------	--------	--------	--------	--------	--------	--------	--------	--------	--------	--------	--------	--------	--------	--------	--------	--------	--------	--------	--------	--------	--------	--------	--------	--------	--------	--------	--------	--------	--------	--------	--------	--------	--------	--------	--------	--------	--------	--------	--------	--------	--------	--------	--------	--------	--------	--------	--------	--------	--------	--------	--------	--------	--------	--------	--------	--------	--------	--------	--------	--------	--------	--------	--------	--------	--------	--------	--------	--------	--------	--------	--------	--------	--------	--------	--------	--------	--------	--------	--------	--------	--------	--------	--------	--------	--------	--------	--------	--------	--------	--------	--------	--------	--------	--------	--------	--------	--------	--------	--------	--------	--------	--------	--------	--------	--------	--------	--------	--------	--------	--------	--------	--------	--------	--------	--------	--------	--------	--------	--------	--------	--------	--------	--------	--------	--------	--------	--------	--------	--------	--------	--------	--------	--------	--------	--------	--------	--------	--------	--------	--------	--------	--------	--------	--------	--------	--------	--------	--------	--------	--------	--------	--------	--------	--------	--------	--------	--------	--------	--------	--------	--------	--------	--------	--------	--------	--------	--------	--------	--------	--------	--------	--------	--------	--------	--------	--------	--------	--------	--------	--------	--------	--------	--------	--------	--------	--------	--------	--------	--------	--------	--------	--------	--------	--------	--------	--------	--------	--------	--------	--------	--------	--------	--------	--------	--------	--------	--------	--------	--------	--------	--------	--------	--------	--------	--------	--------	--------	--------	--------	--------	--------	--------	--------	--------	--------	--------	--------	--------	--------	--------	--------	--------	--------	--------	--------	--------	--------	--------	--------	--------	--------	--------	--------	--------	--------	--------	--------	--------	--------	--------	--------	--------	--------	--------	--------	--------	--------	--------	--------	--------	--------	--------	--------	--------	--------	--------	--------	--------	--------	--------	--------	--------	--------	--------	--------	--------	--------	--------	--------	--------	--------	--------	--------	--------	--------	--------	--------	--------	--------	--------	--------	--------	--------	--------	--------	--------	--------	--------	--------	--------	--------	--------	--------	--------	--------	--------	--------	--------	--------	--------	--------	--------	--------	--------	--------	--------	--------	--------	--------	--------	--------	--------	--------	--------	--------	--------	--------	--------	--------	--------	--------	--------	--------	--------	--------	--------	--------	--------	--------	--------	--------	--------	--------	--------	--------	--------	--------	--------	--------	--------	--------	--------	--------	--------	--------	--------	--------	--------	--------	--------	--------	--------	--------	--------	--------	--------	--------	--------	--------	--------	--------	--------	--------	--------	--------	--------	--------	--------	--------	--------	--------	--------	--------	--------	--------	--------	--------	--------	--------	--------	--------	--------	--------	--------	--------	--------	--------	--------	--------	--------	--------	--------	--------	--------	--------	--------	--------	--------	--------	--------	--------	--------	--------	--------	--------	--------	--------	--------	--------	--------	--------	--------	--------	--------	--------	--------	--------	--------	--------	--------	--------	--------	--------	--------	--------	--------	--------	--------	--------	--------	--------	--------	--------	--------	--------	--------	--------	--------	--------	--------	--------	--------	--------	--------	--------	--------	--------	--------	--------	--------	--------	--------	--------	--------	--------	--------	--------	--------	--------	--------	--------	--------	--------	--------	--------	--------	--------	--------	--------	--------	--------	--------	--------	--------	--------	--------	--------	--------	--------	--------	--------	--------	--------

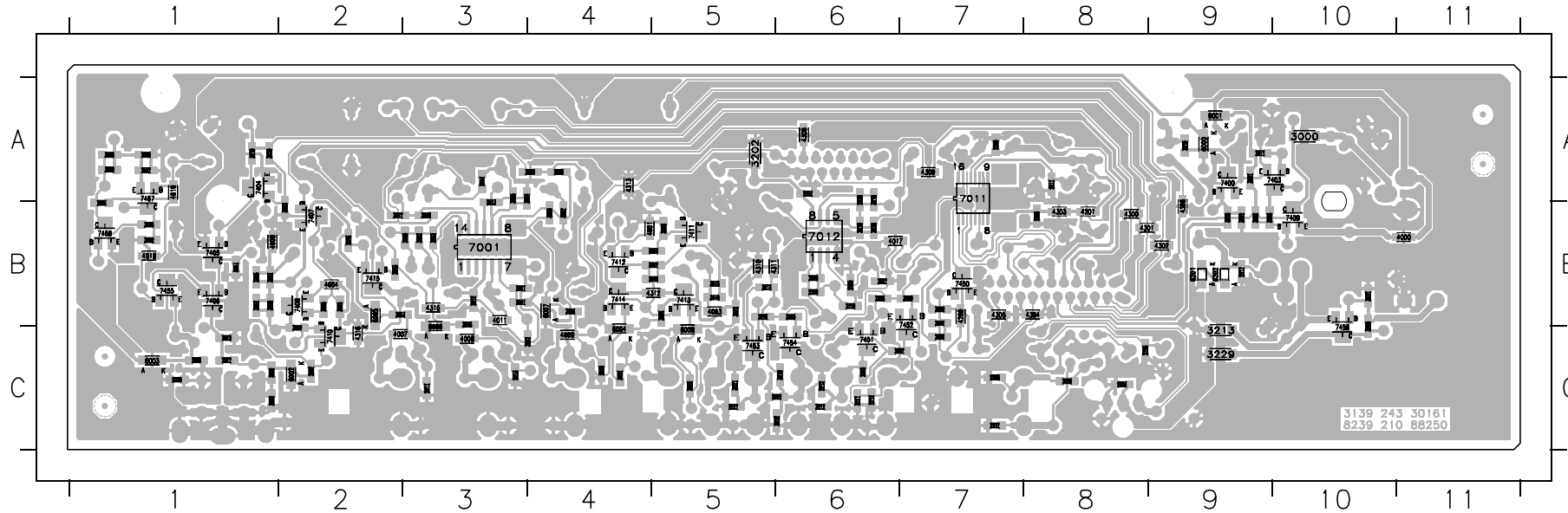

1 ■ PRINTED CIRCUIT BOARD

A/V (B, G)

1300 A4	2357 A9	2385 A9	2488 B1	2524 B4	2535 B5	3036 B7	3322 A8	3409 B5	3508 B1	3618 A3	3691 A8	3720 B2	3764 A5	6401 A8	7330 A5	7407 B2	7921 A8
1301 A5	2359 A9	2412 A6	2496 A8	2525 B5	2536 B5	3038 B7	3338 A8	3413 B5	3511 A2	3620 A4	3692 A8	3722 B3	3765 A5	6403 A3	7331 A3	7900 B6	7922 A7
1303 B7	2360 A8	2452 A3	2497 A9	2527 B5	2537 B5	3039 B7	3339 A8	3425 B4	3512 A2	3621 A4	3693 A8	3723 B2	3766 A2	6404 A5	7332 A3	7901 B5	7935 B3
1304 B9	2361 A8	2453 A2	2498 A9	2528 B5	2538 B3	3040 B7	3340 A8	3432 A7	3519 A1	3623 A4	3694 B7	3729 B7	3767 A3	7006 B7	7333 A4	7902 B4	7943 B2
1402 B3	2372 A8	2456 A2	2506 A6	2529 B6	2539 A7	3041 B7	3341 A8	3433 A6	3610 A4	3625 A4	3695 B2	3742 B7	3772 B5	7007 B7	7334 A4	7903 B4	7944 A5
1405 B2	2375 A8	2460 A1	2507 A7	2530 A4	2540 A7	3043 B7	3348 A8	3442 B3	3612 A5	3626 A3	3696 B3	3743 B7	3773 B5	7008 B7	7335 A4	7904 B5	7948 A2
1410 A1	2378 A9	2462 A3	2508 A6	2531 A5	2541 B6	3044 B7	3351 A9	3446 B3	3613 A4	3627 A4	3704 A8	3750 B7	3774 B5	7009 B7	7400 A3	7905 B5	
2353 A9	2382 A9	2469 A2	2509 A8	2532 B6	2542 A5	3045 B7	3363 A9	3462 B3	3614 A5	3629 A8	3705 A8	3760 B7	5400 B1	7010 B7	7401 A1	7917 A9	
2354 A7	2383 A9	2471 A1	2511 B6	2533 B5	2544 B2	3046 B7	3407 A8	3505 B1	3615 A3	3634 A1	3706 A8	3761 B7	6302 A3	7304 A7	7402 A2	7919 A8	
2355 A9	2384 B6	2472 B2	2519 B1	2534 A5	2545 A4	3321 A8	3408 A8	3507 B1	3616 A3	3635 A8	3707 B7	3762 A5	6400 B1	7329 A4	7404 B3	7920 A8	

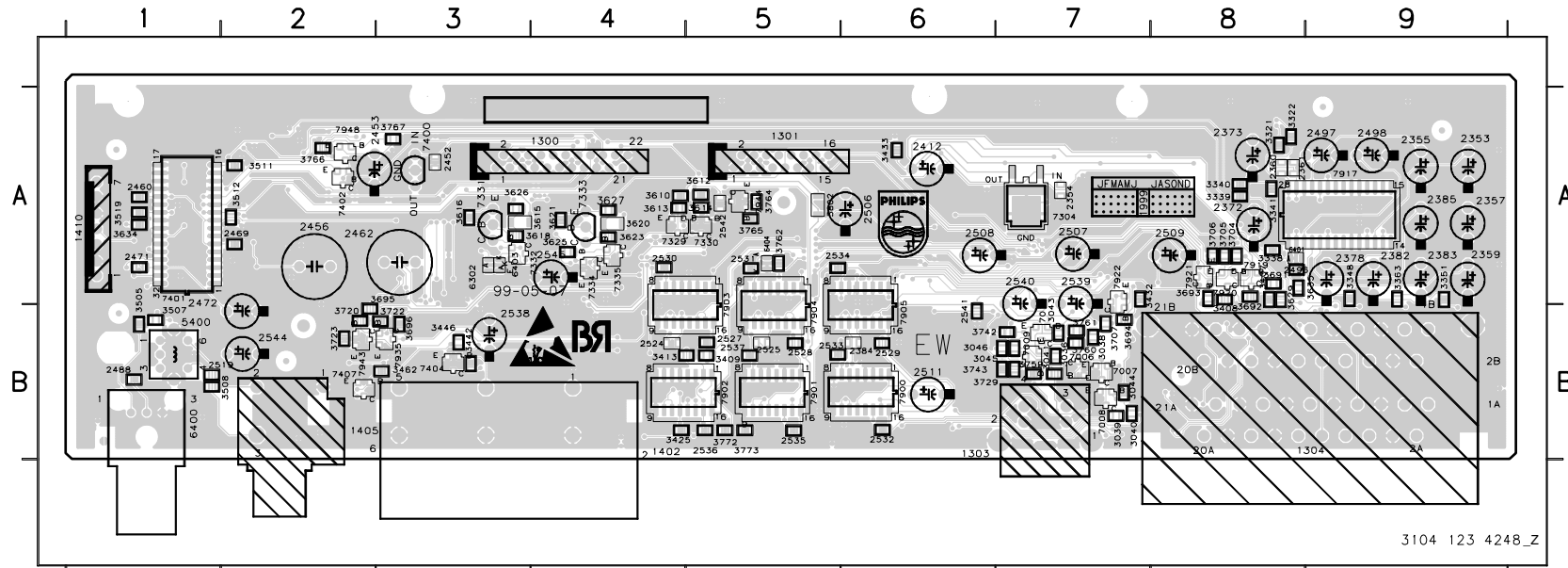

2032 B3	2504 B2	3323 B1	3464 A8	3653 B4	3701 B2	3746 B7	3805 B5	7934 B4									
2358 B1	2505 B3	3325 B1	3517 A8	3672 A4	3702 A4	3747 A2	3999 A5	7936 A4									
2371 B2	2520 B3	3343 B2	3611 A6	3673 A3	3703 A2	3748 A2	7011 B3	7937 A3									
2377 B6	2521 B1	3345 B6	3617 A7	3674 A3	3721 A2	3749 A4	7012 B3	7938 A4									
2395 B1	2522 B1	3347 B6	3619 A7	3675 A2	3724 B4	3750 B6	7013 B3	7939 A2									
2402 B2	2523 B1	3349 B1	3622 A6	3676 A2	3725 A3	3751 B7	7014 B3	7941 B4									
2404 B1	2543 B9	3359 B1	3624 A6	3677 A4	3726 A3	3752 B7	7300 B6	7942 A2									
2408 B2	3049 B3	3366 B1	3631 A8	3678 A4	3727 A4	3753 B3	7301 B6	7945 B6									
2409 B2	3050 B4	3394 A1	3632 A8	3679 A4	3728 B3	3754 B3	7310 B6	7946 B5									
2450 A8	3056 B3	3397 B1	3636 A4	3680 A3	3730 B6	3755 B3	7403 A8	7947 B5									
2455 A8	3058 B3	3444 A9	3637 A4	3681 A3	3731 A2	3756 A3	7405 B7	7949 B5									
2457 B7	3059 B3	3445 B7	3638 A3	3682 A4	3732 B4	3757 A3	7406 B7										
2458 A8	3062 B3	3447 B7	3639 A3	3683 A4	3733 B4	3758 B4	7918 A2										
2459 A8	3063 B2	3448 A9	3640 A4	3684 A2	3734 A3	3763 B6	7923 A4										
2461 A8	3300 B7	3451 A9	3641 A3	3685 A2	3735 A3	3768 A5	7924 A4										
2463 B7	3301 B6	3453 A8	3642 A2	3687 B4	3736 A3	3769 B5	7925 A3										
2464 A8	3313 B1	3454 A8	3643 A2	3688 B4	3737 A3	3770 B6	7926 A3										
2495 B8	3314 B1	3455 A9	3646 B4	3689 A4	3738 A4	3771 B5	7927 A3										
2499 B2	3315 B1	3456 A7	3647 B4	3690 A2	3739 A4	3774 B6	7928 A3										
2500 B2	3316 B1	3457 B8	3648 A4	3697 A4	3740 B3	3800 B4	7929 A2										
2501 B2	3318 B1	3459 A9	3649 A3	3698 A3	3741 B3	3801 A2	7930 A2										
2502 B1	3319 B1	3461 B7	3650 A4	3699 A3	3744 A2	3803 A6	7931 B4										
2503 B2	3320 B1	3463 B7	3651 A2	3700 A2	3745 B6	3804 B5	7933 A4										

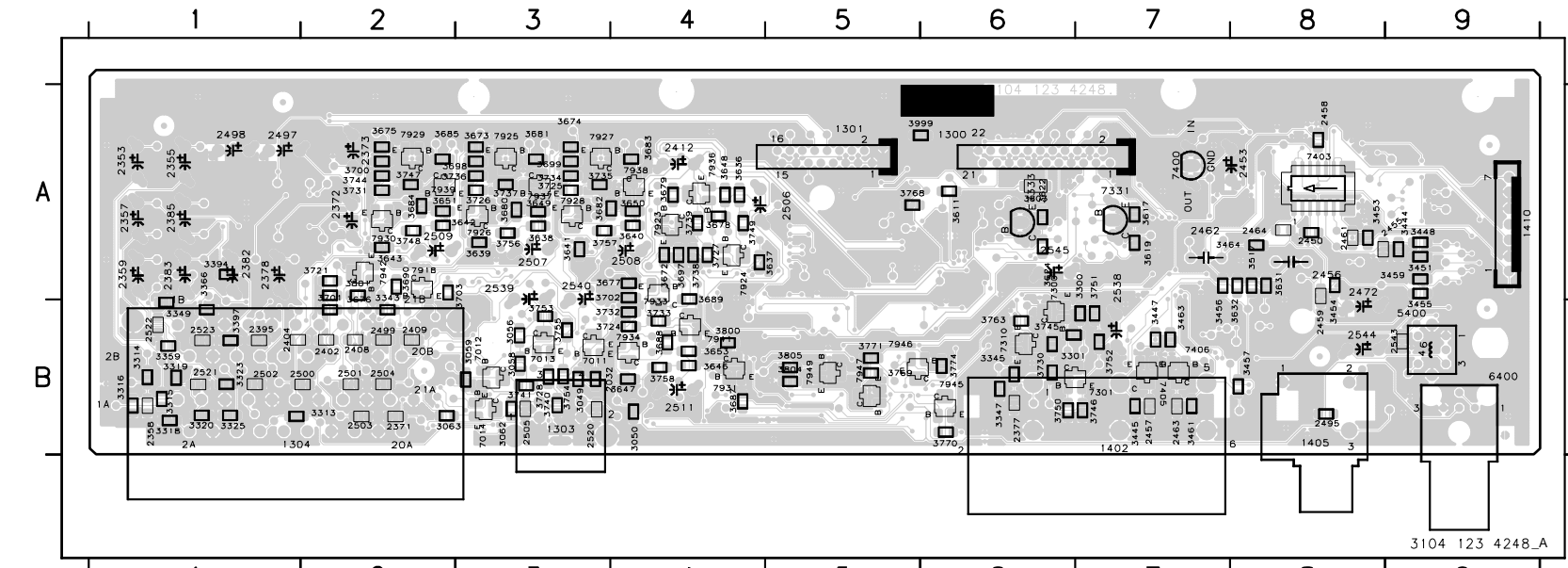

PRINTED CIRCUIT BOARD DISPLAY

1100 A9101 A9102 A8106 A9107 A8108 A9109 A8110 A4112 A9113 A4115 A7116 A8117 A1118 A1119 A6121 A9122 A9106 A7117 A2123 A2124 A2126 A2129 A2130 A7105 A7106 A7110 A7112 A7

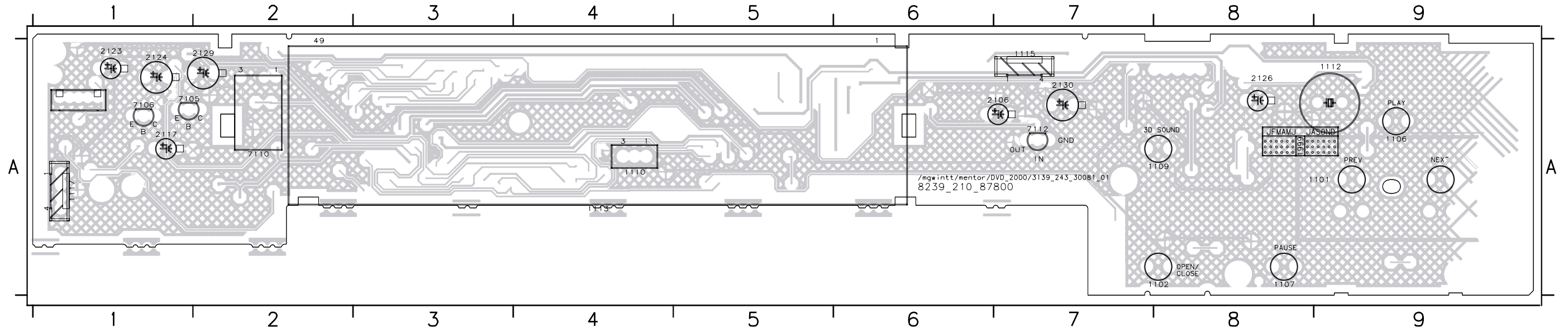

2100 A2103 A8108 A2111 A2116 A9120 A2125 A9201 A13100 A2103 A8106 A2109 A8112 A13115 A3118 A2121 A9125 A9128 A3131 A9134 A9137 A9140 A2144 A2147 A4150 A6102 A7100 A7103 A7108 A1
2101 A2105 A8109 A2114 A9118 A2121 A2120 A2202 A4101 A2104 A3107 A4110 A8113 A8116 A8119 A3122 A9126 A9129 A3132 A9135 A9138 A8142 A9145 A8148 A6100 A6104 A7101 A7104 A6109 A9
2102 A8107 A8110 A2115 A9119 A2122 A8131 A2211 A8102 A2105 A8108 A8111 A13114 A8117 A3120 A8123 A3127 A3130 A9133 A9136 A2139 A9143 A9146 A4149 A6101 A6105 A7102 A7107 A9

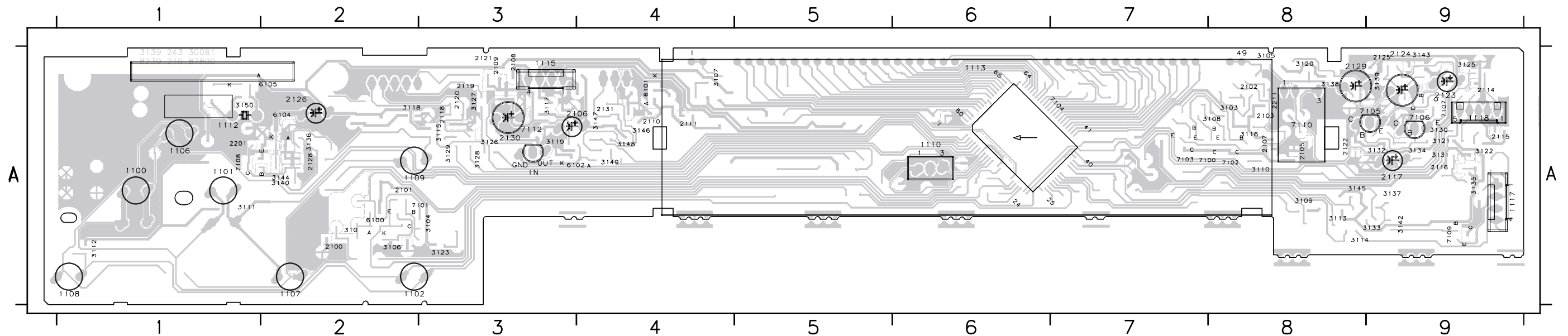

PRINTED CIRCUIT BOARD
POWER (B, G)

0101 B1 0208 B9 2122 C2 2129 C4 2134 C5 2232 A7 2240 A7 2259 C8 3111 C4 3126 B4 3133 A3 3201 C6 5125 B4 5223 C6 6110 C3 6132 C5 6231 B6 6261 A6 7150 C3 7255 C7 9202 C8 9207 B9
 0125 C4 1120 C1 2123 B3 2130 A4 2141 C4 2235 A8 2241 A6 2260 A7 3120 C1 3127 B4 3134 C3 3233 B8 5131 B6 5230 B7 6111 C3 6140 C4 6240 B6 7125 B4 7201 C6 7259 C7 9203 C8
 0205 C9 2119 B2 2125 B3 2131 C5 2210 C7 2236 B6 2250 C6 2261 A7 3121 C3 3128 B4 3135 C5 3262 C6 5135 B5 5231 B7 6120 A3 6210 B7 6241 A7 7131 C6 7233 A8 9101 A1 9204 B9
 0206 C8 2120 C2 2126 A3 2132 C5 2211 B7 2238 B7 2251 B6 2263 A6 3122 B2 3129 C4 3140 B4 5120 A2 5210 C7 5240 A7 6122 C3 6211 C6 6250 B6 7141 C3 7236 B7 9122 C2 9205 B9
 0207 A9 2121 B3 2127 B4 2133 C5 2230 B7 2239 B8 2253 C7 3105 C1 3123 B2 3132 A4 3155 C4 5121 B2 5222 C6 5260 A7 6123 B2 6230 B6 6260 A6 7145 C4 7237 B8 9201 C6 9206 A8

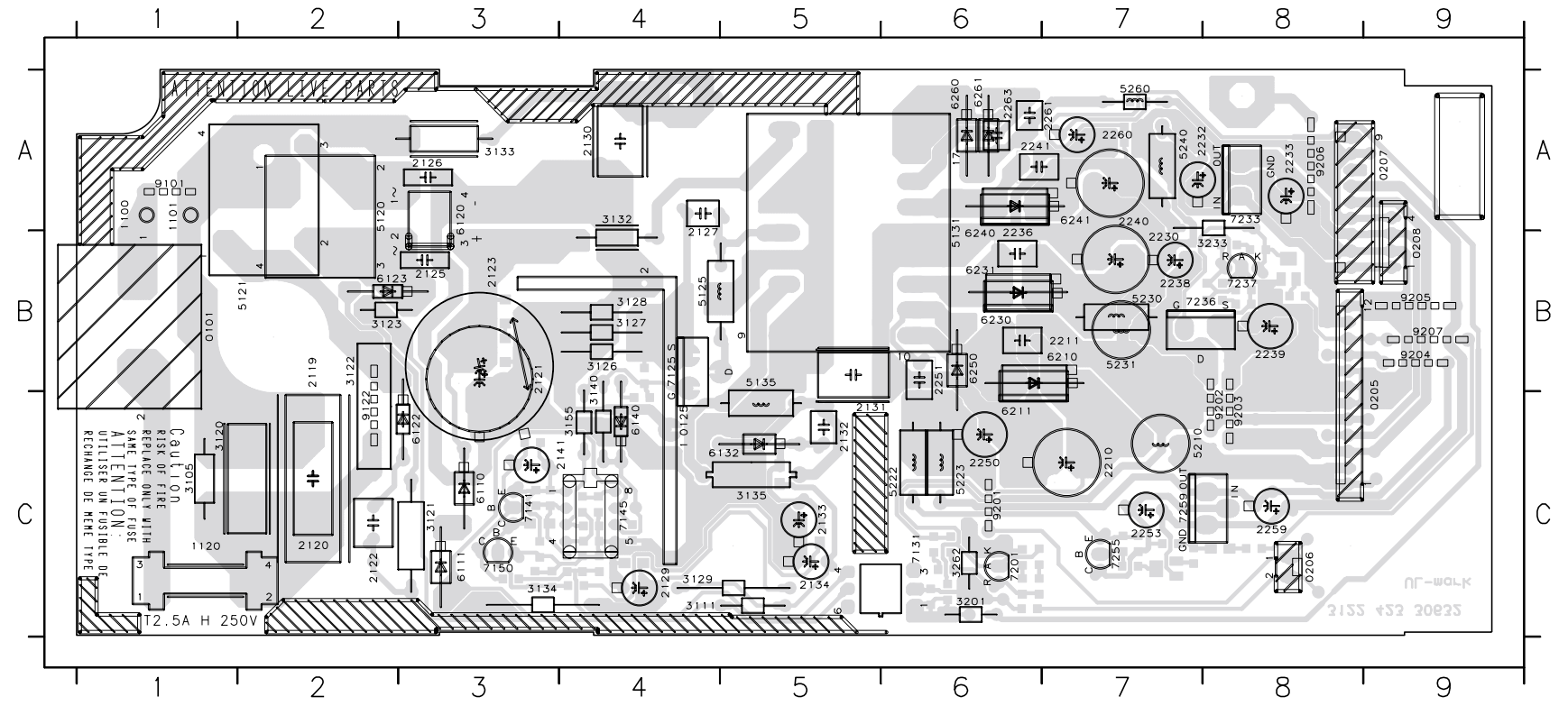

2142 A3 2146 A4 2156 A4 2202 A6 2262 B8 3136 B3 3143 A3 3150 A3 3156 A4 3204 A6 3207 A6 3235 B8 3241 B8 3255 A7 3258 A8 4202 C7 6141 A5 7235 B8
 2143 A4 2150 A3 2157 A4 2203 A6 3125 B4 3139 A4 3145 A3 3153 A4 3202 A6 3205 A6 3208 A6 3236 B8 3253 A7 3256 A7 3260 C7 6129 A4 6150 A3 7256 A7
 2145 A3 2152 A4 2201 A6 2234 B8 3131 B3 3141 A3 3146 A4 3154 A4 3203 A6 3206 A6 3234 B8 3237 B8 3254 A7 3257 A7 4201 B7 6133 A5 6256 A8

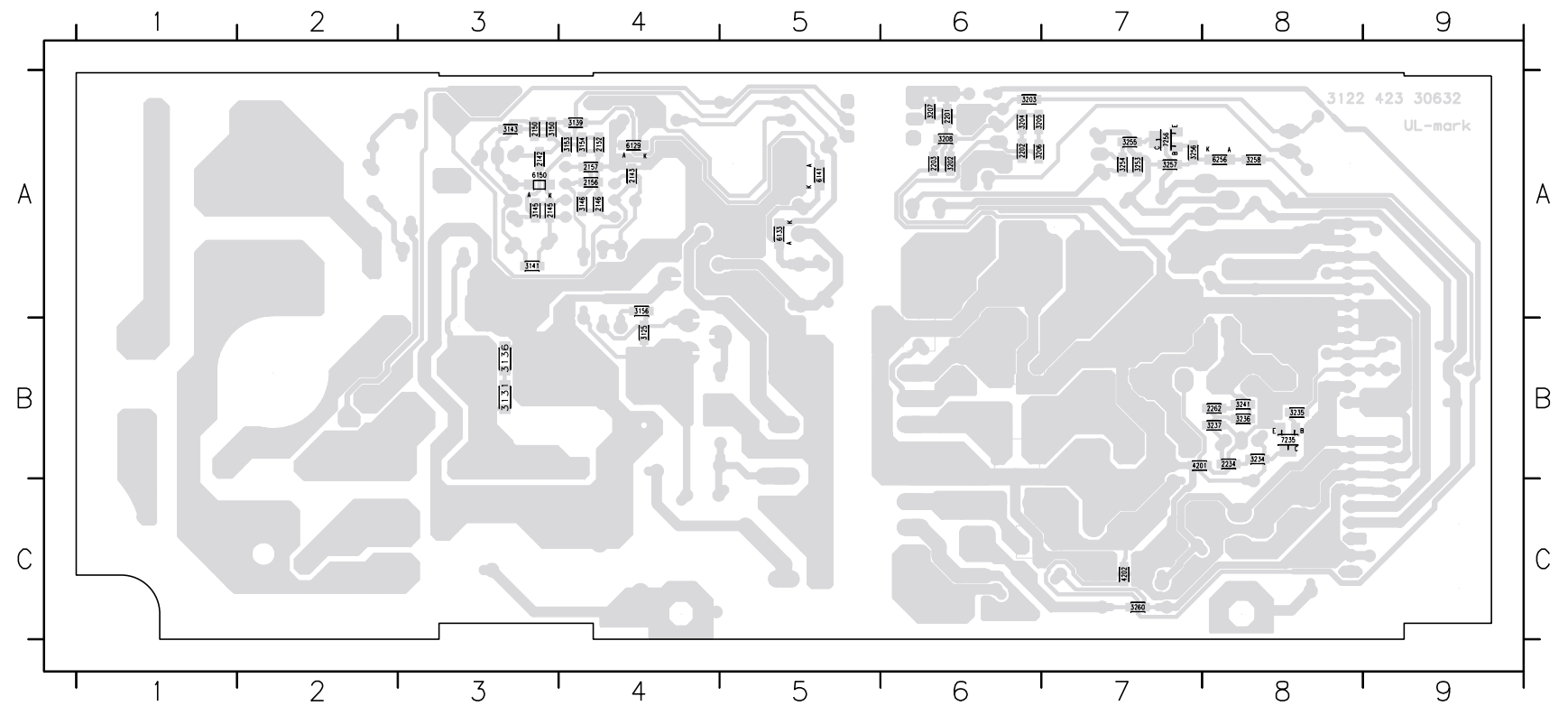

■ PRINTED CIRCUIT BOARD

VOLUME

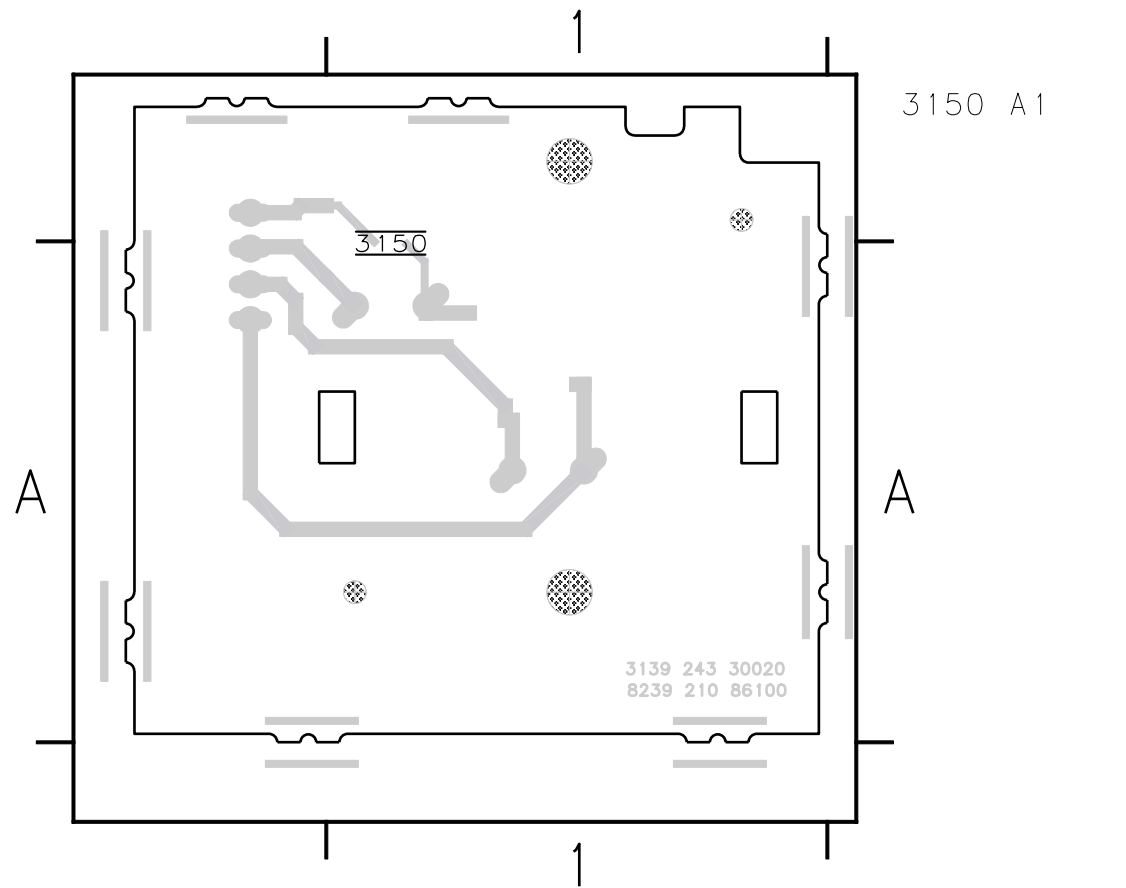
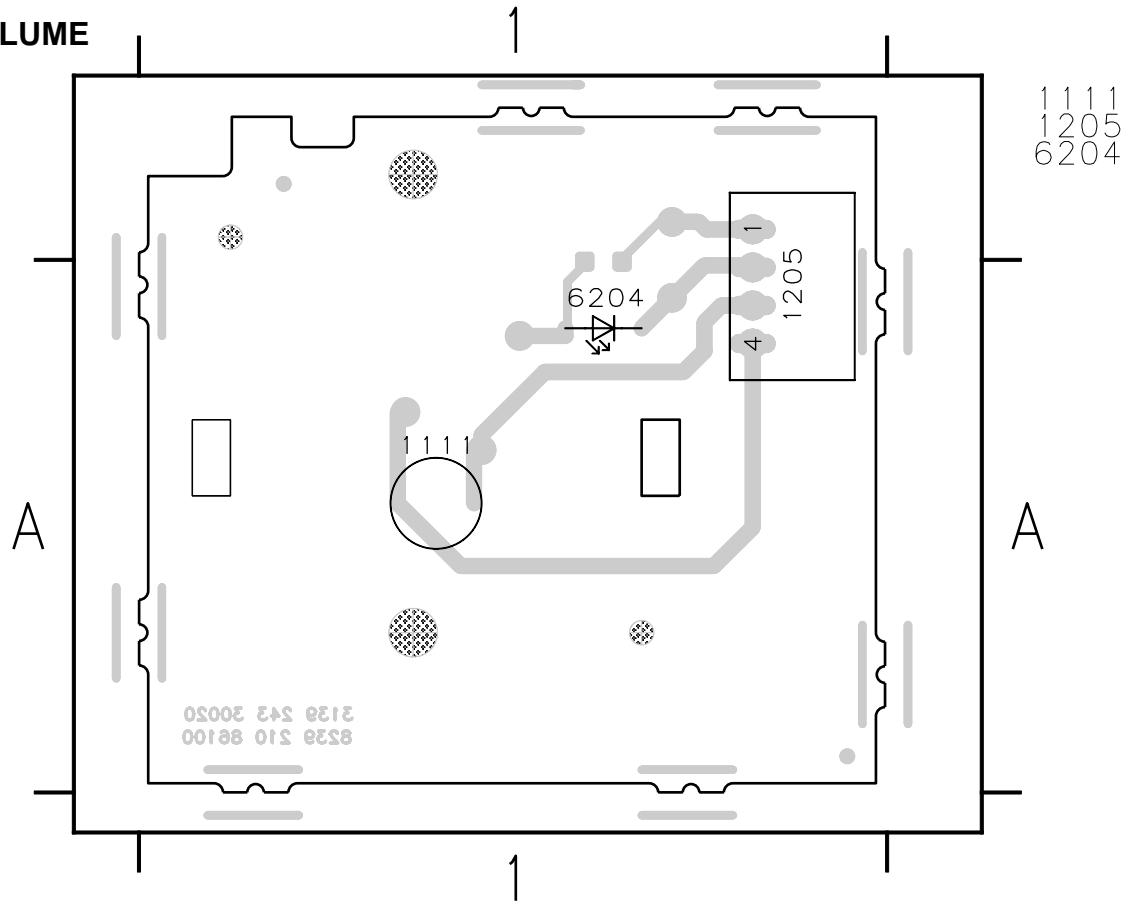

■ SCHEMATIC DIAGRAM

VOLUME

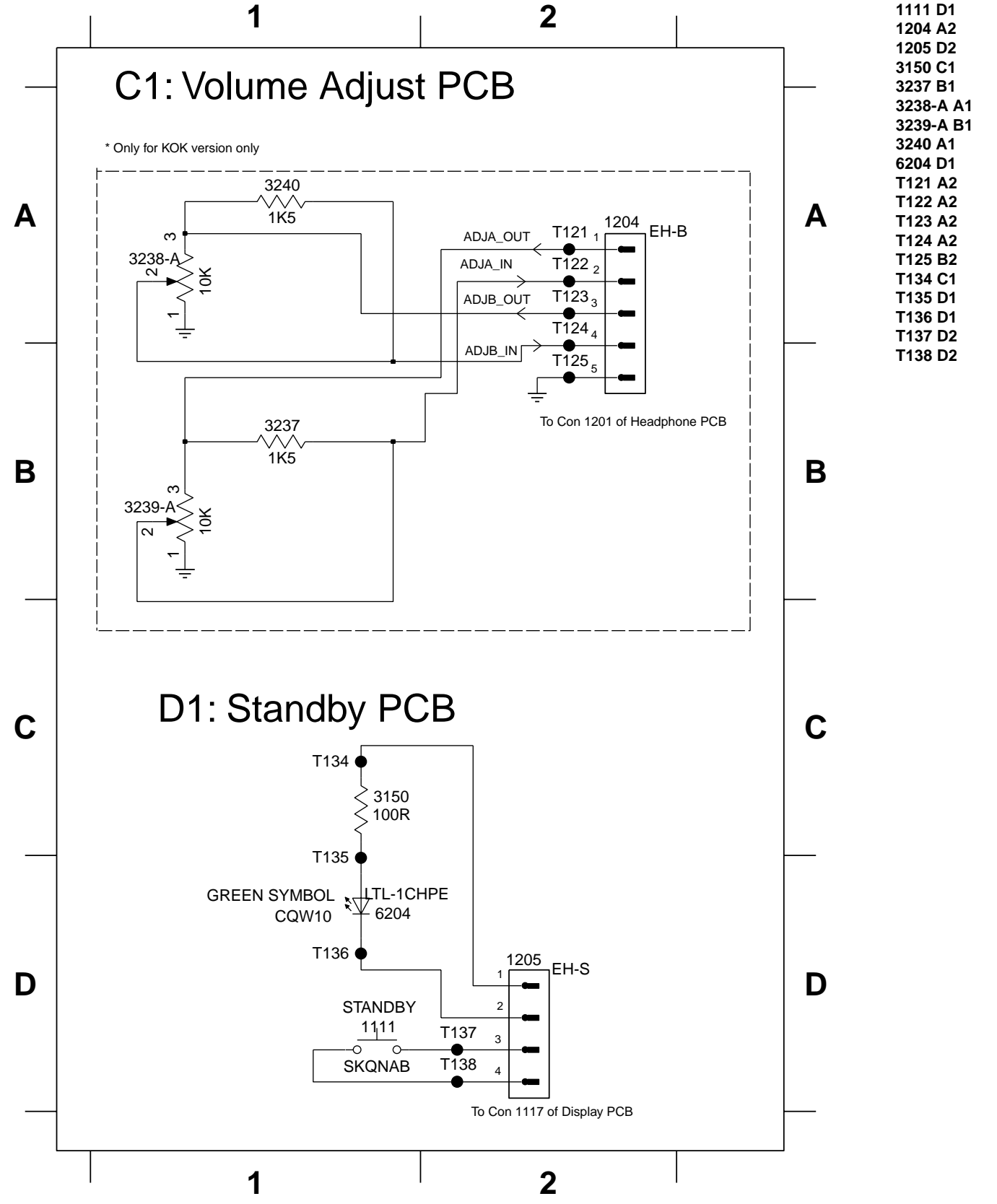

- 1111 D1
- 1204 A2
- 1205 D2
- 3150 C1
- 3237 B1
- 3238-A A1
- 3239-A B1
- 3240 A1
- 6204 D1
- T121 A2
- T122 A2
- T123 A2
- T124 A2
- T125 B2
- T134 C1
- T135 D1
- T136 D1
- T137 D2
- T138 D2

SCHEMATIC DIAGRAM

MONO 2/6 (SERVO MACE)

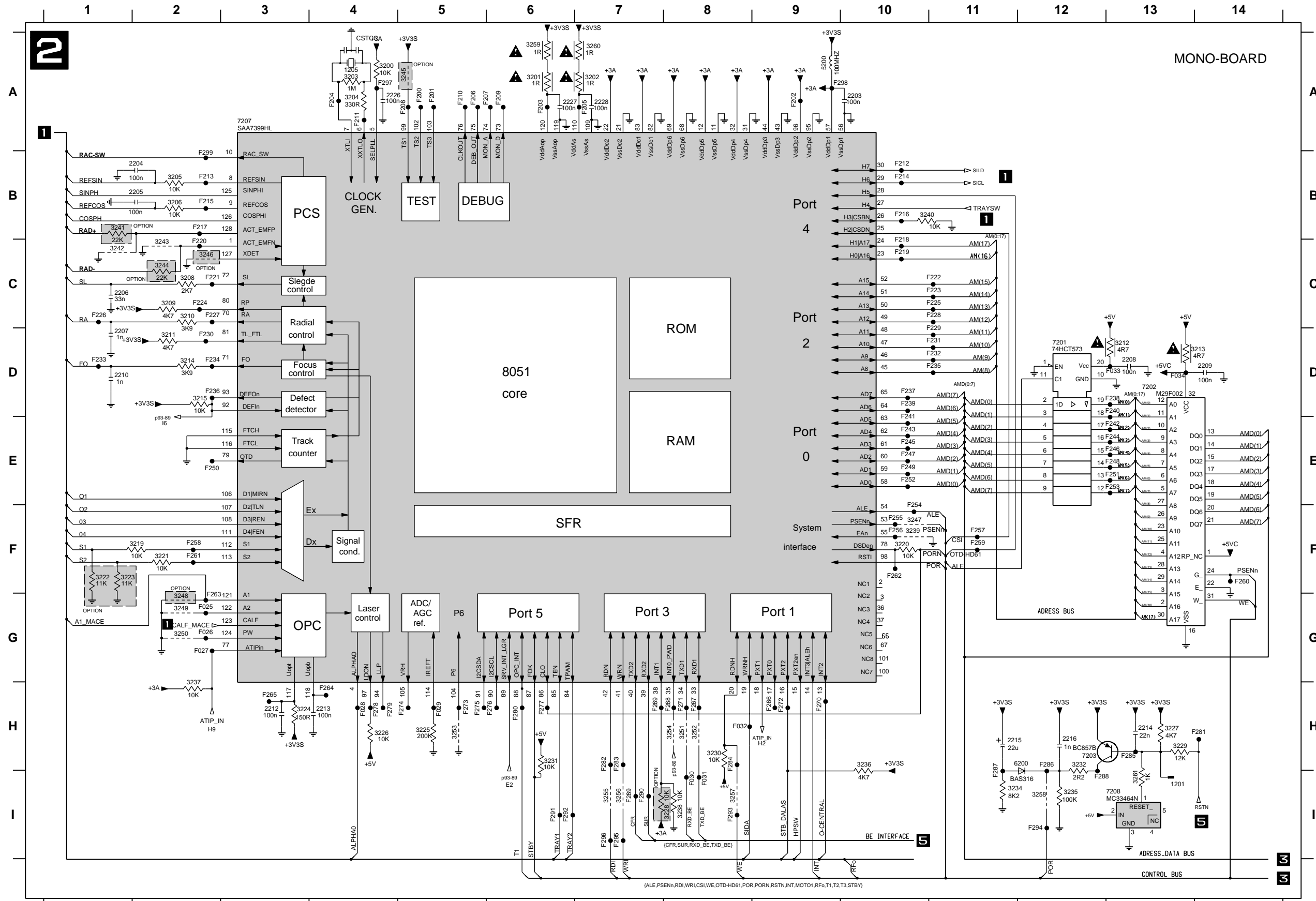

- 1201 I13 F226 C1
- 1205 A4 F227 C2
- 2203 A10 F228 C11
- 2204 B2 F229 D11
- 2205 B2 F230 D2
- 2206 C1 F231 D11
- 2207 D1 F232 D11
- 2208 D13 F233 D1
- 2209 D14 F234 D2
- 2210 D1 F235 D11
- 2212 H3 F236 D2
- 2213 H4 F237 D10
- 2214 H13 F238 D13
- 2215 H11 F239 D10
- 2216 H12 F240 D13
- 2226 A4 F241 E10
- 2227 A6 F242 E13
- 2228 A7 F243 E10
- 3200 A4 F244 E13
- 3201 A6 F245 E10
- 3202 A7 F246 E13
- 3203 A4 F247 E10
- 3204 A4 F248 E13
- 3205 B2 F249 E10
- 3206 B2 F250 E2
- 3208 C2 F251 E13
- 3209 C2 F252 E10
- 3210 C2 F253 E13
- 3211 D2 F254 F10
- 3212 D13 F255 F10
- 3213 D14 F256 F10
- 3214 D2 F257 F11
- 3215 D2 F258 F11
- 3219 F2 F259 F11
- 3220 F10 F260 F14
- 3221 F2 F261 F2
- 3222 F1 F262 F10
- 3223 F1 F263 G2
- 3224 H3 F264 H4
- 3225 H5 F265 H3
- 3226 H4 F266 H9
- 3227 H13 F267 H8
- 3228 I8 F268 H8
- 3229 H13 F269 H7
- 3230 H8 F270 H9
- 3231 H6 F271 H8
- 3232 H12 F272 H9
- 3234 H1 F273 H5
- 3235 I12 F274 H5
- 3236 H10 F275 H5
- 3237 H2 F276 H6
- 3238 I8 F277 H6
- 3239 F10 F278 H4
- 3240 B10 F279 H4
- 3241 B1 F280 H6
- 3242 C1 F281 H14
- 3243 C2 F282 H7
- 3244 C2 F283 H7
- 3245 A5 F284 H8
- 3246 C2 F285 H13
- 3247 F10 F286 H12
- 3248 G2 F287 I11
- 3249 G2 F288 I12
- 3250 G2 F289 I7
- 3251 H8 F290 I7
- 3252 H8 F291 I6
- 3253 H5 F292 I6
- 3254 H8 F293 I8
- 3255 I7 F294 I12
- 3256 I7 F295 I7
- 3257 I8 F296 I7
- 3258 I12 F297 A4
- 3259 A6 F298 A10
- 3260 A7 F299 B2
- 3261 I13
- 5200 A9
- 6200 H12
- 7201 D12
- 7202 D13
- 7203 H12
- 7207 A3
- 7208 I13
- F025 G2
- F026 G2
- F027 G2
- F028 H4
- F029 H5
- F030 I8
- F031 I8
- F032 H8
- F033 D13
- F034 D13
- F200 A5
- F201 A5
- F202 A9
- F203 A6
- F204 A4
- F205 A7
- F206 A5
- F207 A6
- F208 A5
- F209 A6
- F210 A5
- F211 A4
- F212 B10
- F213 B2
- F214 B10
- F215 B2
- F216 B10
- F217 B2
- F218 C10
- F219 C10
- F220 C2
- F221 C2
- F222 C11
- F223 C11
- F224 C2
- F225 C11

SCHEMATIC DIAGRAM

MONO 3/6 (Decoder & Turntable motor control)

MONO-BOARD

3

A
2
3
4
5
6
7

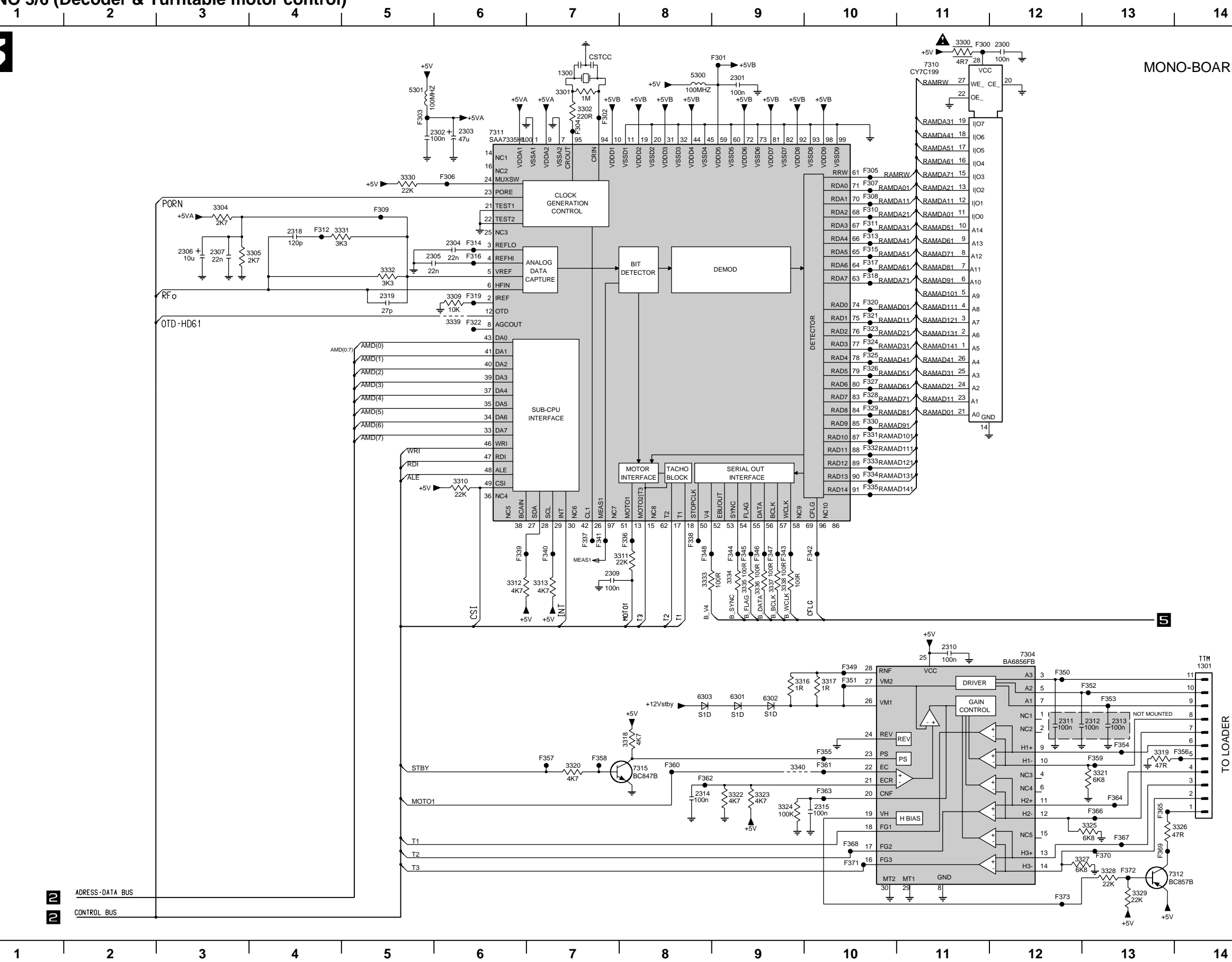

- 1300 A7
- 1301 G14
- 2300 A12
- 2301 A9
- 2302 A6
- 2303 A6
- 2304 B6
- 2305 C5
- 2306 C3
- 2307 C3
- 2309 F7
- 2310 G11
- 2311 H12
- 2312 H13
- 2313 H13
- 2314 H8
- 2315 I10
- 2318 B4
- 2319 C5
- 3300 A11
- 3301 A7
- 3302 A7
- 3304 B3
- 3305 C4
- 3309 C6
- 3310 E6
- 3311 F8
- 3312 F6
- 3313 F7
- 3316 G9
- 3317 G10
- 3318 H8
- 3319 H13
- 3320 H7
- 3321 H13
- 3322 H9
- 3323 H9
- 3324 I9
- 3325 I13
- 3326 I14
- 3327 I13
- 3328 I13
- 3329 I13
- 3330 B5
- 3331 B5
- 3332 C5
- 3333 F8
- 3334 F9
- 3335 F9
- 3336 F9
- 3337 F9
- 3338 F9
- 3339 C6
- 3340 H9
- 5300 A8
- 5301 A5
- 6301 G9
- 6302 G9
- 6303 G8
- 7304 G12
- 7310 A11
- 7311 A6
- 7312 I13
- 7315 H8
- F300 A11
- F301 A9
- F302 A7
- F303 A5
- F304 A7
- F305 B10
- F306 B6
- F307 B10
- F308 B10
- F309 B5
- F310 B10
- F311 B10
- F312 B4
- F313 B10
- F314 B6
- F315 B10
- F316 C6
- F317 C10
- F318 C10
- F319 C6
- F320 C10
- F321 C10
- F322 C6
- F323 C10
- F324 C10
- F325 D10
- F326 D10
- F327 D10
- F328 D10
- F329 D10
- F330 D10
- F331 D10
- F332 E10
- F333 E10
- F334 E10
- F335 E10
- F336 F8
- F337 F7
- F338 F8
- F339 F6
- F340 F7
- F341 F7
- F342 F10
- F343 F9
- F344 F9
- F345 F9
- F346 F9
- F347 F9
- F348 F8
- F349 G10
- F350 G12
- F351 G10
- F352 G13
- F353 G13
- F354 H13
- F355 H10
- F356 H14
- F357 H7
- F358 H7
- F359 H13
- F360 H8
- F361 H10
- F362 H8
- F363 H10
- F364 H13
- F365 H13
- F366 H13
- F367 H13
- F368 H10
- F369 H13
- F370 I13
- F371 I10
- F372 I13
- F373 I12

SCHEMATIC DIAGRAM

MONO 4/6 (Memory)

4

MEMORY PART

MONO-BOARD

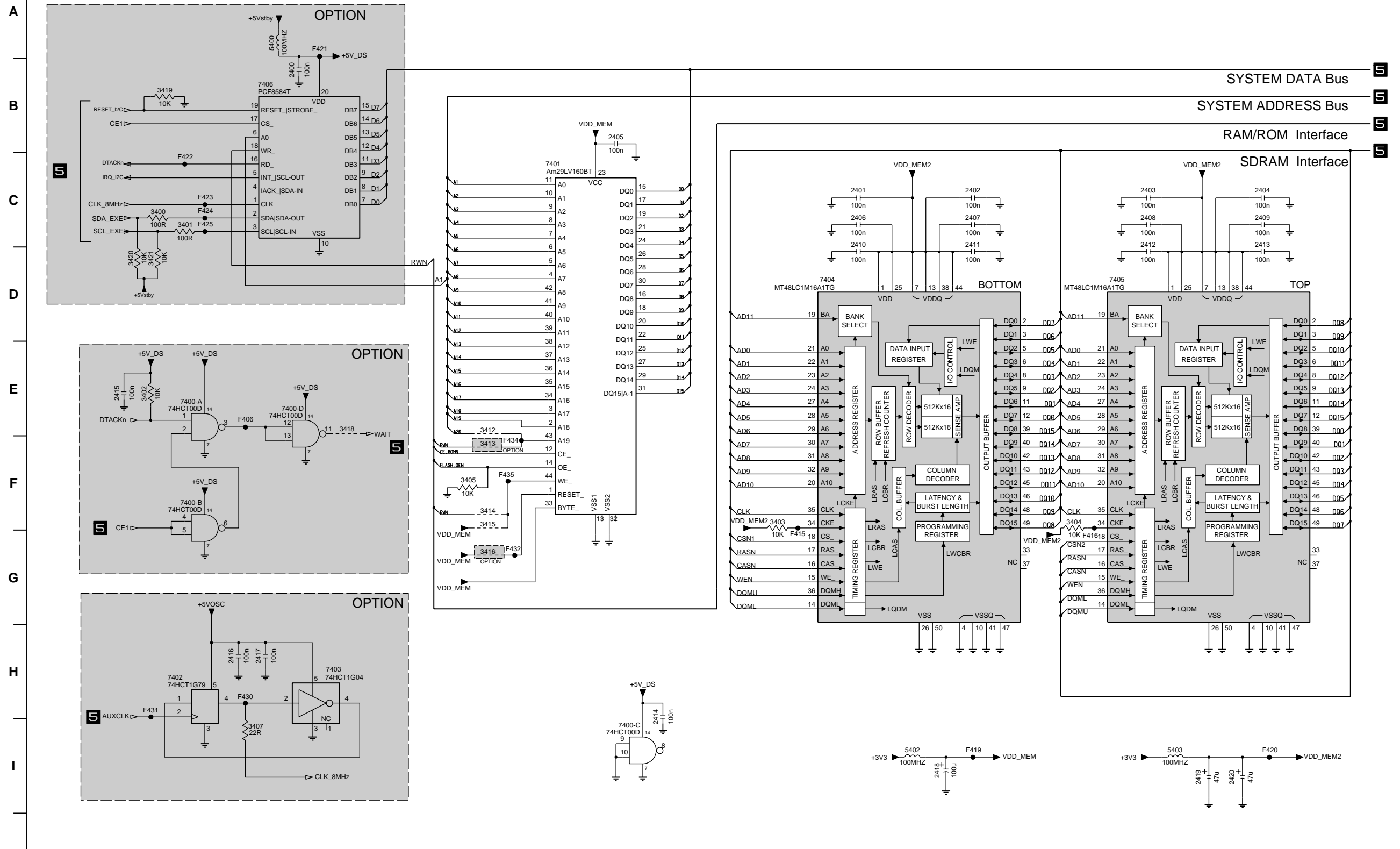

- 2400 B3
- 2401 C9
- 2402 C10
- 2403 C12
- 2404 C13
- 2405 B6
- 2406 C9
- 2407 C10
- 2408 C12
- 2409 C13
- 2410 C9
- 2411 C10
- 2412 C12
- 2413 C13
- 2414 H7
- 2415 E1
- 2416 H2
- 2417 H3
- 2418 I10
- 2419 I13
- 2420 I13
- 3400 C2
- 3401 C2
- 3402 E1
- 3403 F8
- 3404 F11
- 3405 F5
- 3407 I3
- 3412 E5
- 3413 F5
- 3414 F5
- 3415 F5
- 3416 G5
- 3418 E4
- 3419 B2
- 3420 D1
- 3421 D2
- 5400 A3
- 5402 I10
- 5403 I10
- 7400-A E2
- 7400-B F2
- 7400-C I6
- 7400-D E3
- 7401 C6
- 7402 H2
- 7403 H3
- 7404 D9
- 7405 D12
- 7406 B3
- F406 E3
- F415 G8
- F416 G11
- F419 I10
- F420 I13
- F421 A3
- F422 C2
- F423 C2
- F424 C2
- F425 C2
- F430 H3
- F431 H2
- F432 G5
- F434 F5
- F435 F5

SCHEMATIC DIAGRAM MONO 5/6 (DVD Decoder STI 5505)

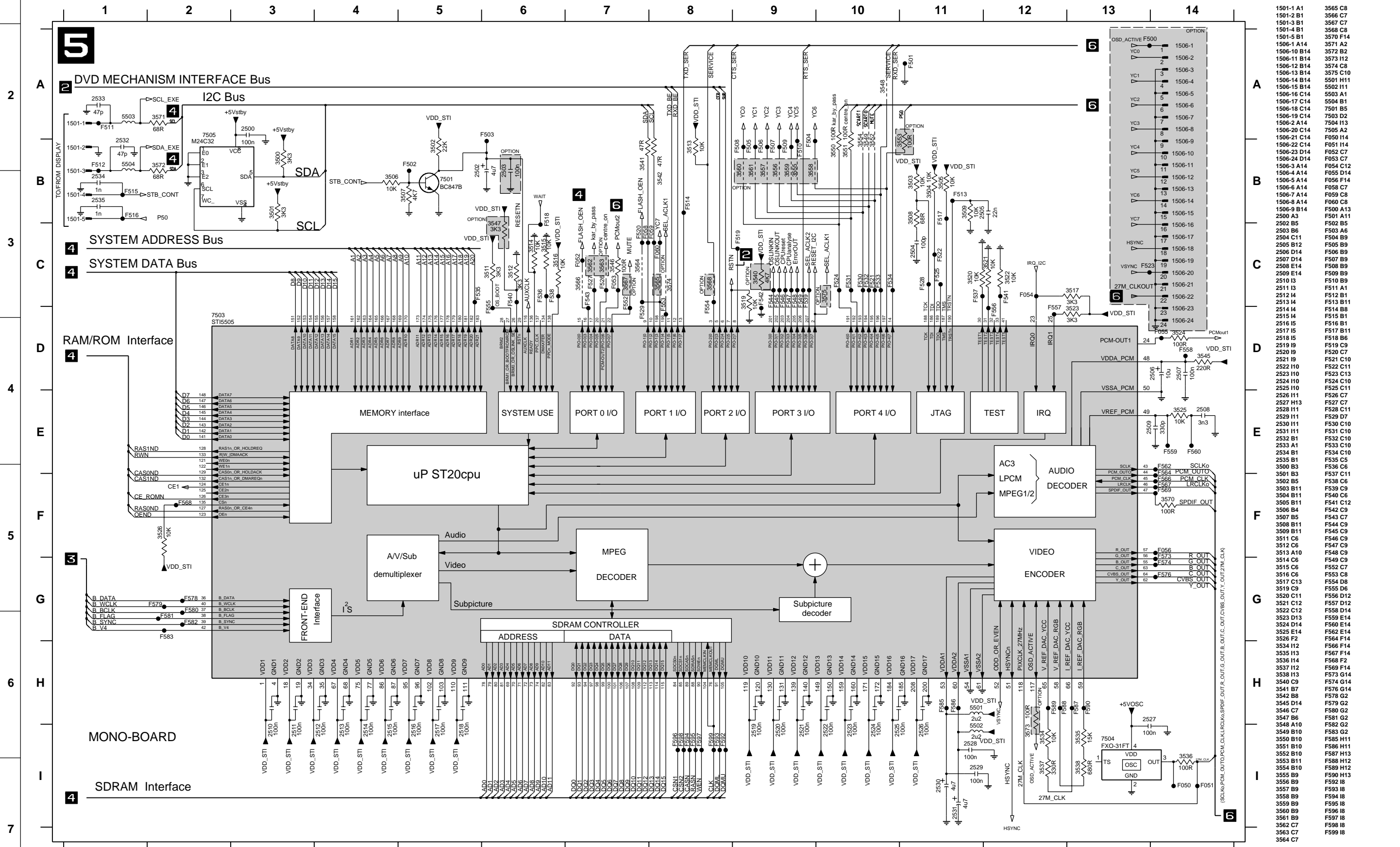

SCHEMATIC DIAGRAM

MONO 6/6 (Back-end & Service interface)

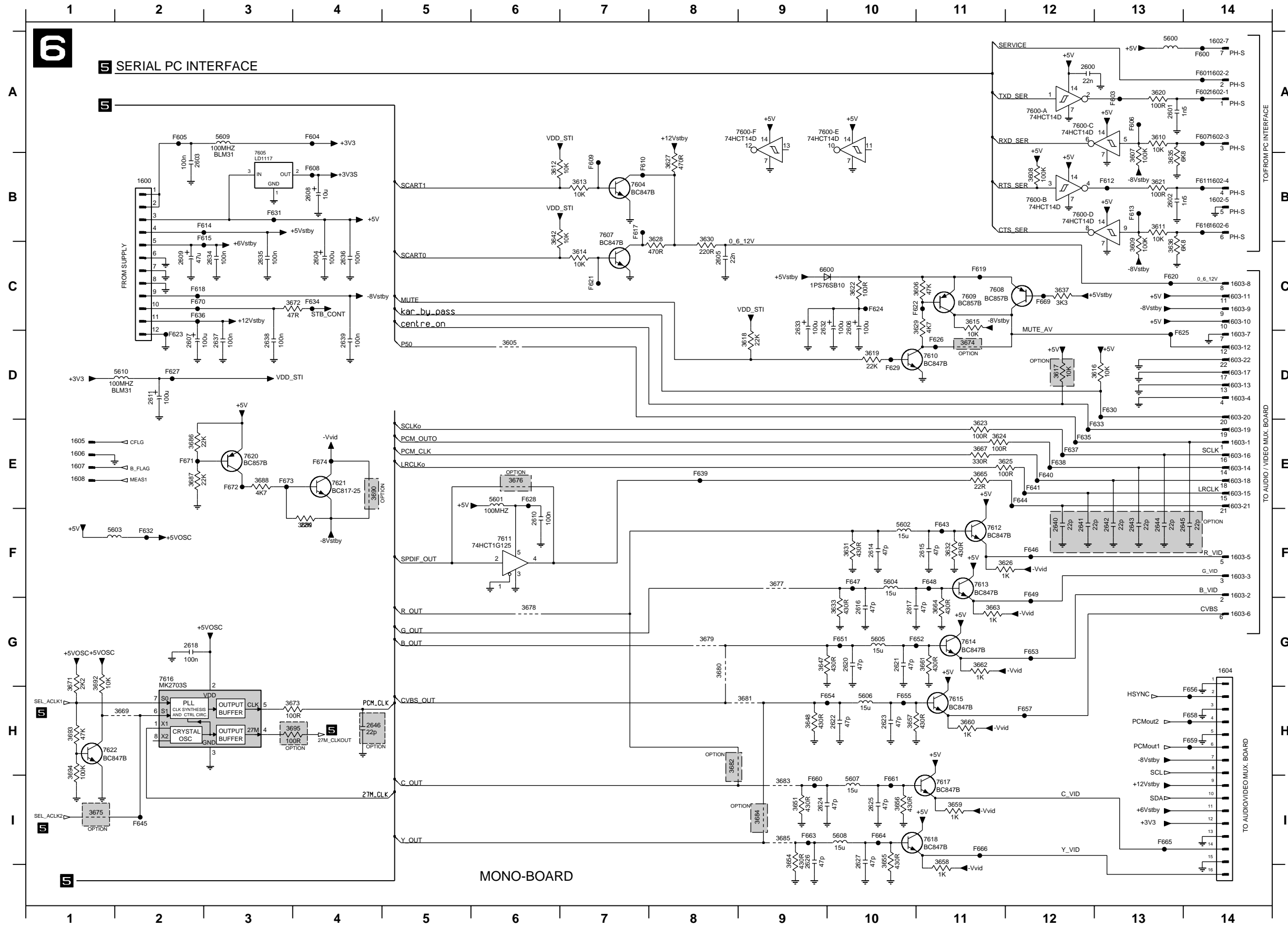

1600 B2	3661 G11	F654 H10
1602-1 A14	3662 G11	F655 H10
1602-2 A14	3663 G11	F656 H10
1602-3 A14	3664 G11	F657 H12
1602-4 B14	3665 E11	F658 H14
1602-5 B14	3667 E11	F659 H14
1602-6 B14	3668 H2	F660 I9
1602-7 A14	3671 G1	F661 H10
1603-1 E14	3672 C4	F663 I9
1603-10 C14	3673 H3	F664 H10
1603-11 C14	3674 D11	F665 I13
1603-12 D14	3675 I1	F666 H11
1603-13 E14	3676 E6	F669 C12
1603-14 E14	3677 F9	F670 C2
1603-15 E14	3678 G6	F671 E2
1603-16 E14	3679 G8	F672 E3
1603-17 D14	3680 G8	F673 E3
1603-18 E14	3681 H9	F674 E4
1603-19 E14	3682 H8	
1603-2 F14	3683 I9	
1603-20 D14	3684 I9	
1603-21 E14	3685 I9	
1603-22 D14	3686 E2	
1603-3 F14	3687 E2	
1603-4 D14	3688 E3	
1603-5 F14	3689 F4	
1603-6 G14	3690 E4	
1603-7 D14	3692 G1	
1603-8 C14	3693 H1	
1603-9 C14	3694 H1	
1604 G14	3695 H4	
1605 E1	5600 A13	
1606 E1	5601 E6	
1607 E1	5602 F10	
1608 E1	5603 F1	
2600 A12	5604 F10	
2601 A13	5605 G10	
2602 B13	5606 H10	
2603 B2	5607 I10	
2604 C4	5608 I10	
2605 C8	5609 A3	
2606 C10	5610 D2	
2607 D2	5610 C9	
2608 B4	7600-A A12	
2609 C2	7600-B B12	
2610 F6	7600-C A12	
2611 D2	7600-D B12	
2614 F10	7600-E A10	
2615 F11	7600-F A9	
2616 G10	7604 B7	
2617 G10	7605 B3	
2618 G2	7607 B7	
2620 G10	7608 C11	
2621 C10	7609 C11	
2622 H10	7610 D11	
2623 H10	7611 F6	
2624 I9	7612 F11	
2625 I10	7613 F11	
2626 I9	7614 G11	
2627 I10	7615 H11	
2632 C9	7616 H2	
2633 C9	7617 I11	
2634 C3	7618 I11	
2635 C3	7620 E3	
2636 C4	7621 E4	
2637 D3	7622 H1	
2638 D3	F600 A14	
2639 D4	F601 A14	
2640 F12	F602 A14	
2641 F12	F603 A13	
2642 F13	F604 A4	
2643 F13	F605 A2	
2644 F13	F606 A13	
2645 F14	F607 A14	
2646 H4	F608 B4	
3605 D6	F609 B7	
3606 C11	F610 B7	
3607 B13	F611 B14	
3608 B12	F612 B13	
3609 C13	F613 B13	
3610 A13	F614 B3	
3611 B13	F615 B3	
3612 B6	F616 B14	
3613 B7	F617 B7	
3614 C7	F618 C2	
3615 C11	F619 C11	
3616 D13	F620 C13	
3617 D12	F621 C7	
3618 D9	F622 C11	
3619 D10	F623 D2	
3620 A13	F624 C10	
3621 B13	F625 D13	
3622 C10	F626 D11	
3623 E11	F627 D2	
3624 E11	F628 E6	
3625 E12	F629 D10	
3626 F12	F630 D13	
3627 B8	F631 B3	
3628 B8	F632 F2	
3629 C11	F633 E13	
3630 B8	F634 C4	
3631 F10	F635 E12	
3632 F11	F636 C2	
3633 G10	F637 E12	
3635 B13	F638 E12	
3636 C13	F639 E8	
3637 C12	F640 E12	
3642 B6	F641 E12	
3647 G9	F643 F11	
3648 H9	F644 E12	
3651 I9	F645 I2	
3654 I9	F646 F12	
3655 I10	F647 F10	
3656 I10	F648 F11	
3657 H10	F649 F12	
3658 I11	F651 G10	
3659 I11	F652 G11	
3660 H11	F653 G12	

■ SCHEMATIC DIAGRAM

A/V (U, C, A, R, T) 1/2

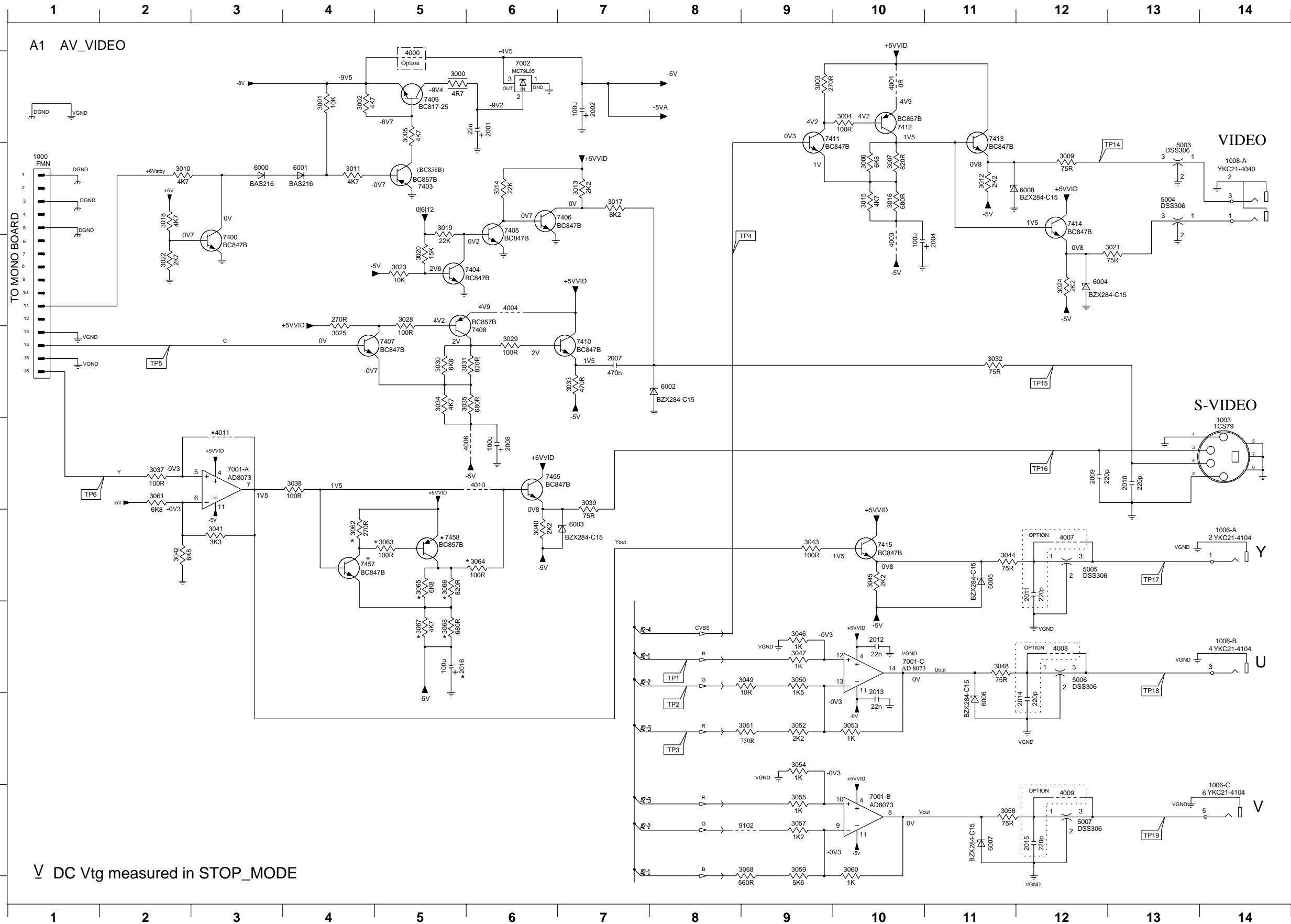

A1 AV_VIDEO

TO MONO BOARD

VIDEO

S-VIDEO

V DC Vtg measured in STOP_MODE

- 1000 B1
- 1003 E14
- 1006-A F14
- 1006-B G14
- 1006-C I14
- 1008-A B14
- 2001 A6
- 2004 C11
- 2007 D7
- 2008 E6
- 2009 E12
- 2010 E13
- 2011 F12
- 2012 G10
- 2013 H10
- 2014 H12
- 2015 I12
- 2016 G5
- 2020 A7
- 3000 A5
- 3001 A4
- 3002 A4
- 3003 A9
- 3004 A10
- 3005 A5
- 3006 B10
- 3007 B10
- 3009 B12
- 3010 B2
- 3011 B4
- 3012 B11
- 3013 B7
- 3014 B6
- 3015 B10
- 3016 B10
- 3017 B7
- 3018 B2
- 3019 B5
- 3020 C5
- 3021 C13
- 3022 C2
- 3023 C5
- 3024 C12
- 3025 D4
- 3028 C5
- 3029 D6
- 3030 D5
- 3031 D6
- 3032 D11
- 3033 D7
- 3034 D5
- 3035 D6
- 3037 E2
- 3038 E4
- 3039 E7
- 3040 F6
- 3041 F3
- 3042 F2
- 3043 F9
- 3044 F11
- 3045 F10
- 3046 G9
- 3047 G9
- 3048 G11
- 3049 G9
- 3050 G9
- 3052 H9
- 3053 H10
- 3054 H9
- 3055 I9
- 3056 I11
- 3057 I9
- 3058 I9
- 3059 I9
- 3060 I10
- 3061 E2
- 3062 F4
- 3063 F5
- 3064 F6
- 3065 F5
- 3066 F5
- 3067 G5
- 3068 G5
- 4000 A5
- 4001 A10
- 4003 C10
- 4004 C6
- 4006 E6
- 4007 F12
- 4008 G12
- 4009 I12
- 4010 E6
- 4011 E3
- 5003 B13
- 5004 B13
- 5005 F12
- 5006 G12
- 5007 I12
- 6000 B3
- 6001 B4
- 6002 D8
- 6003 F7
- 6004 C12
- 6005 F11
- 6006 H11
- 6007 I11
- 6008 B12
- 7001-A E3
- 7001-B I10
- 7001-C G10
- 7002 A6
- 7400 C3
- 7403 B5
- 7404 C5
- 7405 B6
- 7406 B6
- 7407 D5
- 7408 D6
- 7409 A5
- 7410 D7
- 7411 A9
- 7412 A10
- 7413 A11
- 7414 B12
- 7415 F10
- 7455 E6
- 7457 F4
- 7458 F5
- 9102 F9

■ SCHEMATIC DIAGRAM

A/V (U, C, A, R, T) 2/2

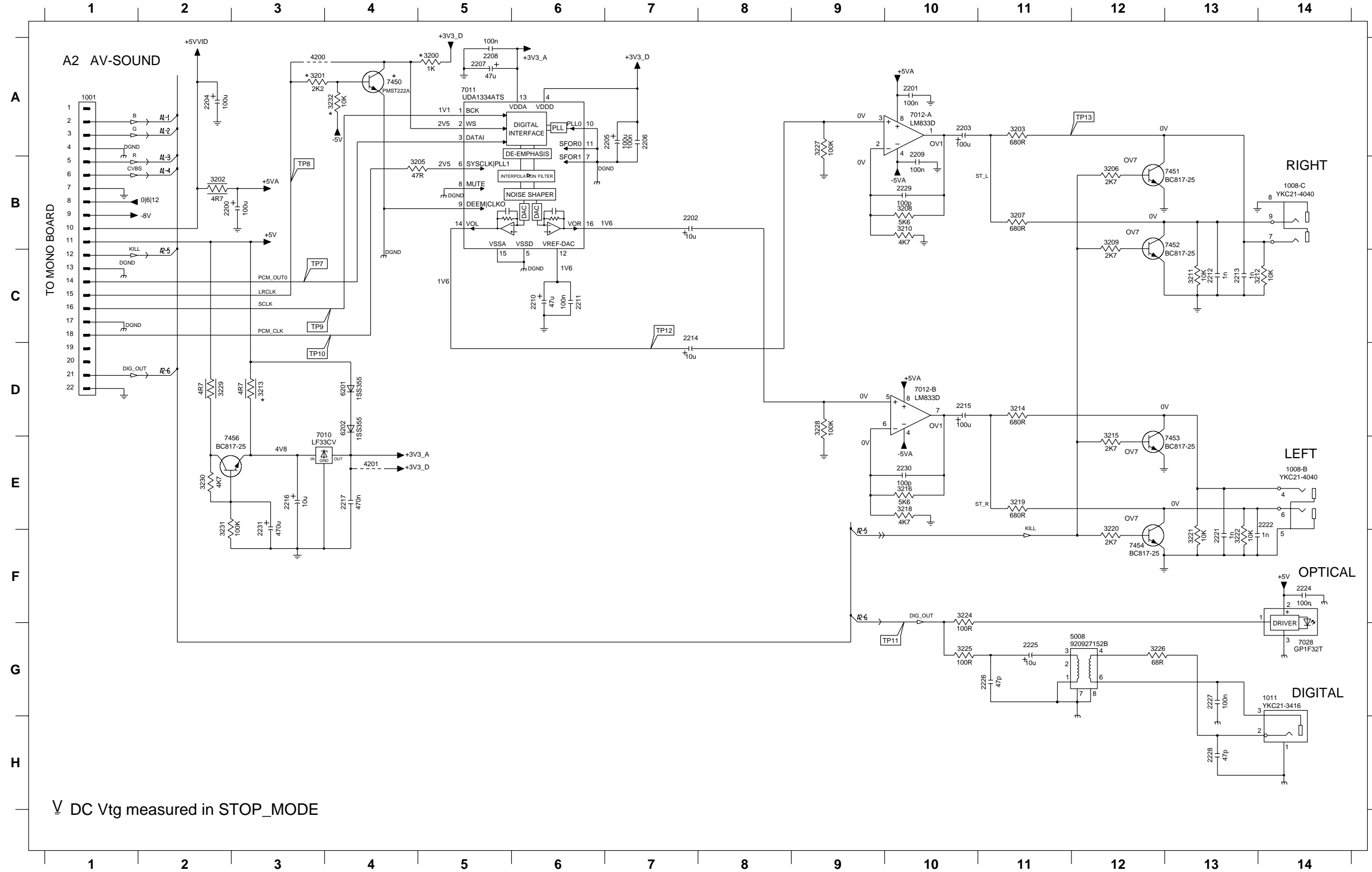

- 1001 A1
- 1008-B E14
- 1008-C B14
- 1011 G14
- 2200 B2
- 2201 A10
- 2202 B7
- 2203 A10
- 2204 A2
- 2205 A7
- 2206 A7
- 2207 A5
- 2208 A5
- 2209 B10
- 2210 C6
- 2211 C6
- 2212 C13
- 2213 C13
- 2214 C7
- 2215 D10
- 2216 E3
- 2217 E4
- 2218 F13
- 2222 E14
- 2224 F14
- 2225 G11
- 2226 G11
- 2227 G13
- 2228 H13
- 2229 B10
- 2230 E10
- 2231 E3
- 3200 A5
- 3201 A3
- 3202 B2
- 3203 A11
- 3205 B4
- 3206 B12
- 3207 B11
- 3208 B10
- 3209 B12
- 3210 B10
- 3211 C13
- 3212 C14
- 3213 D3
- 3214 D11
- 3215 E12
- 3216 E10
- 3218 E10
- 3219 E11
- 3220 F12
- 3221 F13
- 3222 F13
- 3224 F10
- 3225 G10
- 3226 G12
- 3227 A9
- 3228 D9
- 3229 D2
- 3230 E2
- 3231 E2
- 3232 A4
- 4200 A3
- 4201 E4
- 5008 G11
- 6201 D4
- 6202 D4
- 7010 E3
- 7011 A5
- 7012-A A10
- 7012-B D10
- 7028 G14
- 7450 A4
- 7451 B13
- 7452 B13
- 7453 E13
- 7454 F12
- 7456 D3

∇ DC Vtg measured in STOP_MODE

SCHEMATIC DIAGRAM

A/V (B, G) 2/4

1 B AUDIO

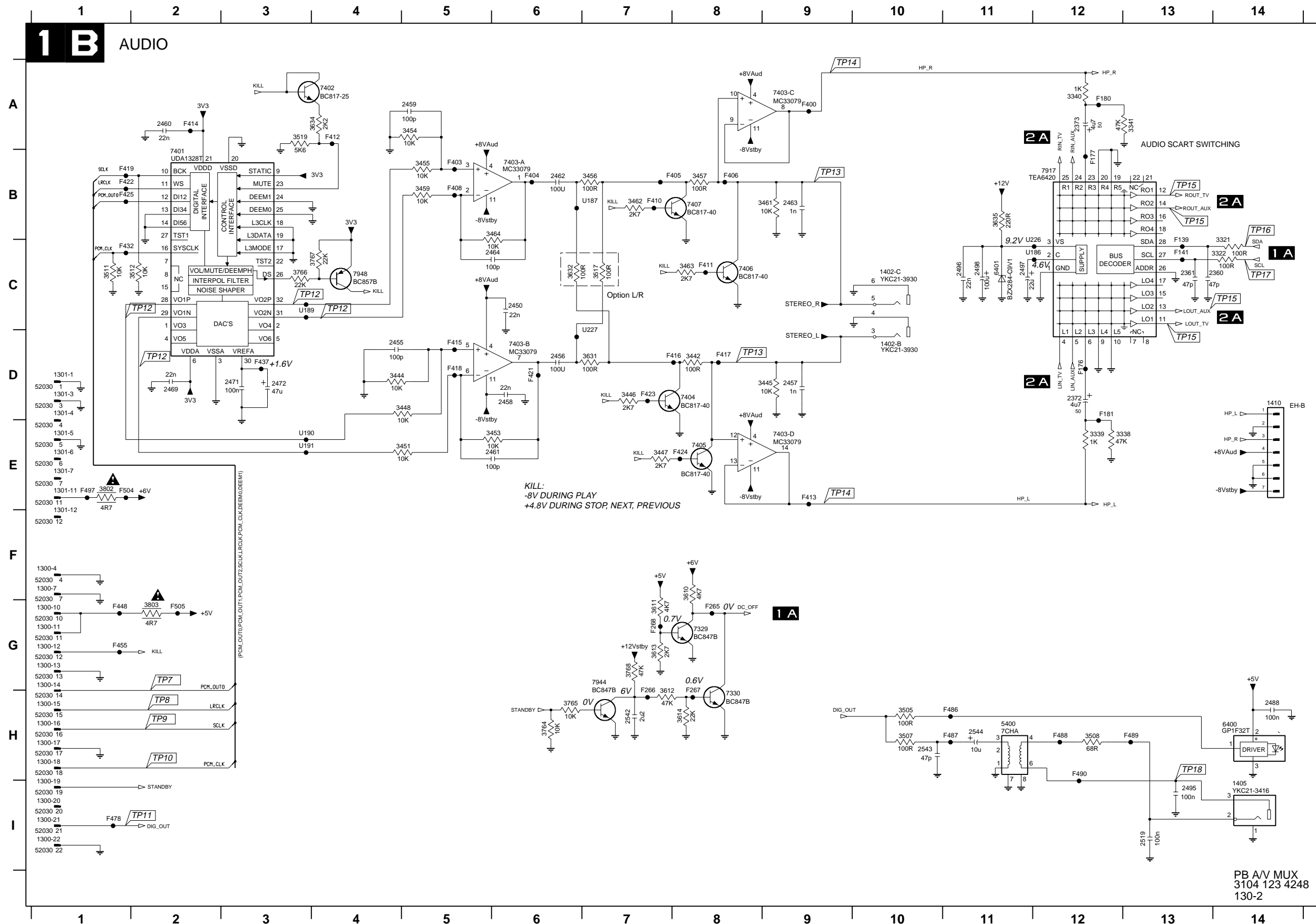

KILL:
 -8V DURING PLAY
 +4.8V DURING STOP, NEXT, PREVIOUS

- 1300-10 G1
- 1300-11 G1
- 1300-12 G1
- 1300-13 G1
- 1300-14 G1
- 1300-15 H1
- 1300-16 H1
- 1300-17 H1
- 1300-18 H1
- 1300-19 I1
- 1300-20 I1
- 1300-21 I1
- 1300-22 I1
- 1300-4 F1
- 1300-7 F1
- 1301-1 D1
- 1301-1 E1
- 1301-12 F1
- 1301-3 D1
- 1301-4 D1
- 1301-5 E1
- 1301-6 E1
- 1301-7 E1
- 1402-B D10
- 1402-C D10
- 1402-D D10
- 1402-E D10
- 1402-F D10
- 1402-G D10
- 1402-H D10
- 1402-I D10
- 1402-J D10
- 1402-K D10
- 1402-L D10
- 1402-M D10
- 1402-N D10
- 1402-O D10
- 1402-P D10
- 1402-Q D10
- 1402-R D10
- 1402-S D10
- 1402-T D10
- 1402-U D10
- 1402-V D10
- 1402-W D10
- 1402-X D10
- 1402-Y D10
- 1402-Z D10
- 1402-AA D10
- 1402-AB D10
- 1402-AC D10
- 1402-AD D10
- 1402-AE D10
- 1402-AF D10
- 1402-AG D10
- 1402-AH D10
- 1402-AI D10
- 1402-AJ D10
- 1402-AK D10
- 1402-AL D10
- 1402-AM D10
- 1402-AN D10
- 1402-AO D10
- 1402-AP D10
- 1402-AQ D10
- 1402-AR D10
- 1402-AS D10
- 1402-AT D10
- 1402-AU D10
- 1402-AV D10
- 1402-AW D10
- 1402-AX D10
- 1402-AY D10
- 1402-AZ D10
- 1402-BA D10
- 1402-BB D10
- 1402-BC D10
- 1402-BD D10
- 1402-BE D10
- 1402-BF D10
- 1402-BG D10
- 1402-BH D10
- 1402-BI D10
- 1402-BJ D10
- 1402-BK D10
- 1402-BL D10
- 1402-BM D10
- 1402-BN D10
- 1402-BO D10
- 1402-BP D10
- 1402-BQ D10
- 1402-BR D10
- 1402-BS D10
- 1402-BT D10
- 1402-BU D10
- 1402-BV D10
- 1402-BW D10
- 1402-BX D10
- 1402-BY D10
- 1402-BZ D10
- 1402-CA D10
- 1402-CB D10
- 1402-CC D10
- 1402-CD D10
- 1402-CE D10
- 1402-CF D10
- 1402-CG D10
- 1402-CH D10
- 1402-CI D10
- 1402-CJ D10
- 1402-CK D10
- 1402-CL D10
- 1402-CM D10
- 1402-CN D10
- 1402-CO D10
- 1402-CP D10
- 1402-CQ D10
- 1402-CR D10
- 1402-CS D10
- 1402-CT D10
- 1402-CU D10
- 1402-CV D10
- 1402-CW D10
- 1402-CX D10
- 1402-CY D10
- 1402-CZ D10
- 1402-DA D10
- 1402-DB D10
- 1402-DC D10
- 1402-DD D10
- 1402-DE D10
- 1402-DF D10
- 1402-DG D10
- 1402-DH D10
- 1402-DI D10
- 1402-DJ D10
- 1402-DK D10
- 1402-DL D10
- 1402-DM D10
- 1402-DN D10
- 1402-DO D10
- 1402-DP D10
- 1402-DQ D10
- 1402-DR D10
- 1402-DS D10
- 1402-DT D10
- 1402-DU D10
- 1402-DV D10
- 1402-DW D10
- 1402-DX D10
- 1402-DY D10
- 1402-DZ D10
- 1402-EA D10
- 1402-EB D10
- 1402-EC D10
- 1402-ED D10
- 1402-EE D10
- 1402-EF D10
- 1402-EG D10
- 1402-EH D10
- 1402-EI D10
- 1402-EJ D10
- 1402-EK D10
- 1402-EL D10
- 1402-EM D10
- 1402-EN D10
- 1402-EO D10
- 1402-EP D10
- 1402-EQ D10
- 1402-ER D10
- 1402-ES D10
- 1402-ET D10
- 1402-EU D10
- 1402-EV D10
- 1402-EW D10
- 1402-EX D10
- 1402-EY D10
- 1402-EZ D10
- 1402-FA D10
- 1402-FB D10
- 1402-FC D10
- 1402-FD D10
- 1402-FE D10
- 1402-FF D10
- 1402-FG D10
- 1402-FH D10
- 1402-FI D10
- 1402-FJ D10
- 1402-FK D10
- 1402-FL D10
- 1402-FM D10
- 1402-FN D10
- 1402-FO D10
- 1402-FP D10
- 1402-FQ D10
- 1402-FR D10
- 1402-FS D10
- 1402-FT D10
- 1402-FU D10
- 1402-FV D10
- 1402-FW D10
- 1402-FX D10
- 1402-FY D10
- 1402-FZ D10
- 1402-GA D10
- 1402-GB D10
- 1402-GC D10
- 1402-GD D10
- 1402-GE D10
- 1402-GF D10
- 1402-GG D10
- 1402-GH D10
- 1402-GI D10
- 1402-GJ D10
- 1402-GK D10
- 1402-GL D10
- 1402-GM D10
- 1402-GN D10
- 1402-GO D10
- 1402-GP D10
- 1402-GQ D10
- 1402-GR D10
- 1402-GS D10
- 1402-GT D10
- 1402-GU D10
- 1402-GV D10
- 1402-GW D10
- 1402-GX D10
- 1402-GY D10
- 1402-GZ D10
- 1402-HA D10
- 1402-HB D10
- 1402-HC D10
- 1402-HD D10
- 1402-HE D10
- 1402-HF D10
- 1402-HG D10
- 1402-HH D10
- 1402-HI D10
- 1402-HJ D10
- 1402-HK D10
- 1402-HL D10
- 1402-HM D10
- 1402-HN D10
- 1402-HO D10
- 1402-HP D10
- 1402-HQ D10
- 1402-HR D10
- 1402-HS D10
- 1402-HT D10
- 1402-HU D10
- 1402-HV D10
- 1402-HW D10
- 1402-HX D10
- 1402-HY D10
- 1402-HZ D10
- 1402-IA D10
- 1402-IB D10
- 1402-IC D10
- 1402-ID D10
- 1402-IE D10
- 1402-IF D10
- 1402-IG D10
- 1402-IH D10
- 1402-II D10
- 1402-IJ D10
- 1402-IK D10
- 1402-IL D10
- 1402-IM D10
- 1402-IN D10
- 1402-IO D10
- 1402-IP D10
- 1402-IQ D10
- 1402-IR D10
- 1402-IS D10
- 1402-IT D10
- 1402-IU D10
- 1402-IV D10
- 1402-IW D10
- 1402-IX D10
- 1402-IY D10
- 1402-IZ D10
- 1402-JA D10
- 1402-JB D10
- 1402-JC D10
- 1402-JD D10
- 1402-JE D10
- 1402-JF D10
- 1402-JG D10
- 1402-JH D10
- 1402-JI D10
- 1402-JJ D10
- 1402-JK D10
- 1402-JL D10
- 1402-JM D10
- 1402-JN D10
- 1402-JO D10
- 1402-JP D10
- 1402-JQ D10
- 1402-JR D10
- 1402-JS D10
- 1402-JT D10
- 1402-JU D10
- 1402-JV D10
- 1402-JW D10
- 1402-JX D10
- 1402-JY D10
- 1402-JZ D10
- 1402-KA D10
- 1402-KB D10
- 1402-KC D10
- 1402-KD D10
- 1402-KE D10
- 1402-KF D10
- 1402-KG D10
- 1402-KH D10
- 1402-KI D10
- 1402-KJ D10
- 1402-KK D10
- 1402-KL D10
- 1402-KM D10
- 1402-KN D10
- 1402-KO D10
- 1402-KP D10
- 1402-KQ D10
- 1402-KR D10
- 1402-KS D10
- 1402-KT D10
- 1402-KU D10
- 1402-KV D10
- 1402-KW D10
- 1402-KX D10
- 1402-KY D10
- 1402-KZ D10
- 1402-LA D10
- 1402-LB D10
- 1402-LC D10
- 1402-LD D10
- 1402-LE D10
- 1402-LF D10
- 1402-LG D10
- 1402-LH D10
- 1402-LI D10
- 1402-LJ D10
- 1402-LK D10
- 1402-LL D10
- 1402-LM D10
- 1402-LN D10
- 1402-LO D10
- 1402-LP D10
- 1402-LQ D10
- 1402-LR D10
- 1402-LS D10
- 1402-LT D10
- 1402-LU D10
- 1402-LV D10
- 1402-LW D10
- 1402-LX D10
- 1402-LY D10
- 1402-LZ D10
- 1402-MA D10
- 1402-MB D10
- 1402-MC D10
- 1402-MD D10
- 1402-ME D10
- 1402-MF D10
- 1402-MG D10
- 1402-MH D10
- 1402-MI D10
- 1402-MJ D10
- 1402-MK D10
- 1402-ML D10
- 1402-MN D10
- 1402-MO D10
- 1402-MP D10
- 1402-MQ D10
- 1402-MR D10
- 1402-MS D10
- 1402-MT D10
- 1402-MU D10
- 1402-MV D10
- 1402-MW D10
- 1402-MX D10
- 1402-MY D10
- 1402-MZ D10
- 1402-NA D10
- 1402-NB D10
- 1402-NC D10
- 1402-ND D10
- 1402-NE D10
- 1402-NF D10
- 1402-NG D10
- 1402-NH D10
- 1402-NI D10
- 1402-NJ D10
- 1402-NK D10
- 1402-NL D10
- 1402-NO D10
- 1402-NP D10
- 1402-NQ D10
- 1402-NR D10
- 1402-NS D10
- 1402-NT D10
- 1402-NU D10
- 1402-NV D10
- 1402-NW D10
- 1402-NX D10
- 1402-NY D10
- 1402-NZ D10
- 1402-OA D10
- 1402-OB D10
- 1402-OC D10
- 1402-OD D10
- 1402-OE D10
- 1402-OF D10
- 1402-OG D10
- 1402-OH D10
- 1402-OI D10
- 1402-OJ D10
- 1402-OK D10
- 1402-OL D10
- 1402-OM D10
- 1402-ON D10
- 1402-OO D10
- 1402-OP D10
- 1402-OQ D10
- 1402-OR D10
- 1402-OS D10
- 1402-OT D10
- 1402-OU D10
- 1402-OV D10
- 1402-OW D10
- 1402-OX D10
- 1402-OY D10
- 1402-OZ D10
- 1402-PA D10
- 1402-PB D10
- 1402-PC D10
- 1402-PD D10
- 1402-PE D10
- 1402-PF D10
- 1402-PG D10
- 1402-PH D10
- 1402-PI D10
- 1402-PJ D10
- 1402-PK D10
- 1402-PL D10
- 1402-PM D10
- 1402-PN D10
- 1402-PO D10
- 1402-PP D10
- 1402-PQ D10
- 1402-PR D10
- 1402-PS D10
- 1402-PT D10
- 1402-PU D10
- 1402-PV D10
- 1402-PW D10
- 1402-PX D10
- 1402-PY D10
- 1402-PZ D10
- 1402-QA D10
- 1402-QB D10
- 1402-QC D10
- 1402-QD D10
- 1402-QE D10
- 1402-QF D10
- 1402-QG D10
- 1402-QH D10
- 1402-QI D10
- 1402-QJ D10
- 1402-QK D10
- 1402-QL D10
- 1402-QM D10
- 1402-QN D10
- 1402-QO D10
- 1402-QP D10
- 1402-QL D10
- 1402-QR D10
- 1402-QS D10
- 1402-QT D10
- 1402-QU D10
- 1402-QV D10
- 1402-QW D10
- 1402-QX D10
- 1402-QY D10
- 1402-QZ D10
- 1402-RA D10
- 1402-RB D10
- 1402-RC D10
- 1402-RD D10
- 1402-RE D10
- 1402-RF D10
- 1402-RG D10
- 1402-RH D10
- 1402-RI D10
- 1402-RJ D10
- 1402-RK D10
- 1402-RL D10
- 1402-RO D10
- 1402-RP D10
- 1402-RQ D10
- 1402-RR D10
- 1402-RS D10
- 1402-RT D10
- 1402-RU D10
- 1402-RV D10
- 1402-RW D10
- 1402-RX D10
- 1402-RY D10
- 1402-RZ D10
- 1402-SA D10
- 1402-SB D10
- 1402-SC D10
- 1402-SD D10
- 1402-SE D10
- 1402-SF D10
- 1402-SG D10
- 1402-SH D10
- 1402-SI D10
- 1402-SJ D10
- 1402-SK D10
- 1402-SL D10
- 1402-SM D10
- 1402-SN D10
- 1402-SO D10
- 1402-SP D10
- 1402-SQ D10
- 1402-SR D10
- 1402-SS D10
- 1402-ST D10
- 1402-SU D10
- 1402-SV D10
- 1402-SW D10
- 1402-SX D10
- 1402-SY D10
- 1402-SZ D10
- 1402-TA D10
- 1402-TB D10
- 1402-TC D10
- 1402-TD D10
- 1402-TE D10
- 1402-TF D10
- 1402-TG D10
- 1402-TH D10
- 1402-TI D10
- 1402-TJ D10
- 1402-TK D10
- 1402-TL D10
- 1402-TM D10
- 1402-TN D10
- 1402-TO D10
- 1402-TP D10
- 1402-TQ D10
- 1402-TR D10
- 1402-TS D10
- 1402-TT D10
- 1402-TU D10
- 1402-TV D10
- 1402-TV D10
- 1402-TW D10
- 1402-TX D10
- 1402-TY D10
- 1402-TZ D10
- 1402-UA D10
- 1402-UB D10
- 1402-UC D10
- 1402-UD D10
- 1402-UE D10
- 1402-UF D10
- 1402-UG D10
- 1402-UH D10
- 1402-UI D10
- 1402-UJ D10
- 1402-UK D10
- 1402-UL D10
- 1402-UM D10
- 1402-UN D10
- 1402-UO D10
- 1402-UP D10
- 1402-UQ D10
- 1402-UR D10
- 1402-US D10
- 1402-UT D10
- 1402-UV D10
- 1402-UW D10
- 1402-UX D10
- 1402-UY D10
- 1402-UZ D10
- 1402-VA D10
- 1402-VB D10
- 1402-VC D10
- 1402-VD D10
- 1402-VE D10
- 1402-VF D10
- 1402-VG D10
- 1402-VH D10
- 1402-VI D10
- 1402-VJ D10
- 1402-VK D10
- 1402-VL D10
- 1402-VM D10
- 1402-VN D10
- 1402-VO D10
- 1402-VP D10
- 1402-VQ D10
- 1402-VR D10
- 1402-VS D10
- 1402-VT D10
- 1402-VU D10
- 1402-VV D10
- 1402-VW D10
- 1402-VX D10
- 1402-VY D10
- 1402-VZ D10
- 1402-WA D10
- 1402-WB D10
- 1402-WC D10
- 1402-WD D10
- 1402-WE D10
- 1402-WF D10
- 1402-WG D10
- 1402-WH D10
- 1402-WI D10
- 1402-WJ D10
- 1402-WK D10
- 1402-WL D10
- 1402-WM D10
- 1402-WN D10
- 1402-WO D10
- 1402-WP D10
- 1402-WQ D10
- 1402-WR D10
- 1402-WS D10
- 1402-WT D10
- 1402-WU D10
- 1402-WV D10
- 1402-WW D10
- 1402-WX D10
- 1402-WY D10
- 1402-WZ D10
- 1402-XA D10
- 1402-XB D10
- 1402-XC D10
- 1402-XD D10
- 1402-XE D10
- 1402-XF D10
- 1402-XG D10
- 1402-XH D10
- 1402-XI D10
- 1402-XJ D10
- 1402-XK D10
- 1402-XL D10
- 1402-XM D10
- 1402-XN D10
- 1402-XO D10
- 1402-XP D10
- 1402-XQ D10
- 1402-XR D10
- 1402-XS D10
- 1402-XT D10
- 1402-XU D10
- 1402-XV D10
- 1402-XW D10
- 1402-XX D10
- 1402-XY D10
- 1402-XZ D10
- 1402-YA D10
- 1402-YB D10
- 1402-YC D10
- 1402-YD D10
- 1402-YE D10
- 1402-YF D10
- 1402-YG D10
- 1402-YH D10
- 1402-YI D10
- 1402-YJ D10
- 1402-YK D10
- 1402-YL D10
- 1402-YM D10
- 1402-YN D10
- 1402-YO D10
- 1402-YP D10
- 1402-YQ D10
- 1402-YR D10
- 1402-YS D10
- 1402-YT D10
- 1402-YU D10
- 1402-YV D10
- 1402-YW D10
- 1402-YX D10
- 1402-YY D10
- 1402-YZ D10
- 1402-ZA D10
- 1402-ZB D10
- 1402-ZC D10
- 1402-ZD D10
- 1402-ZE D10
- 1402-ZF D10
- 1402-ZG D10
- 1402-ZH D10
- 1402-ZI D10
- 1402-ZJ D10
- 1402-ZK D10
- 1402-ZL D10
- 1402-ZM D10
- 1402-ZN D10
- 1402-ZO D10
- 1402-ZP D10
- 1402-ZQ D10
- 1402-ZR D10
- 1402-ZS D10
- 1402-ZT D10
- 1402-ZU D10
- 1402-ZV D10
- 1402-ZW D10
- 1402-ZX D10
- 1402-ZY D10
- 1402-ZZ D10

PB A/V MUX
 3104 123 4248
 130-2

SCHEMATIC DIAGRAM

A/V (B, G) 3/4

2A

SCART

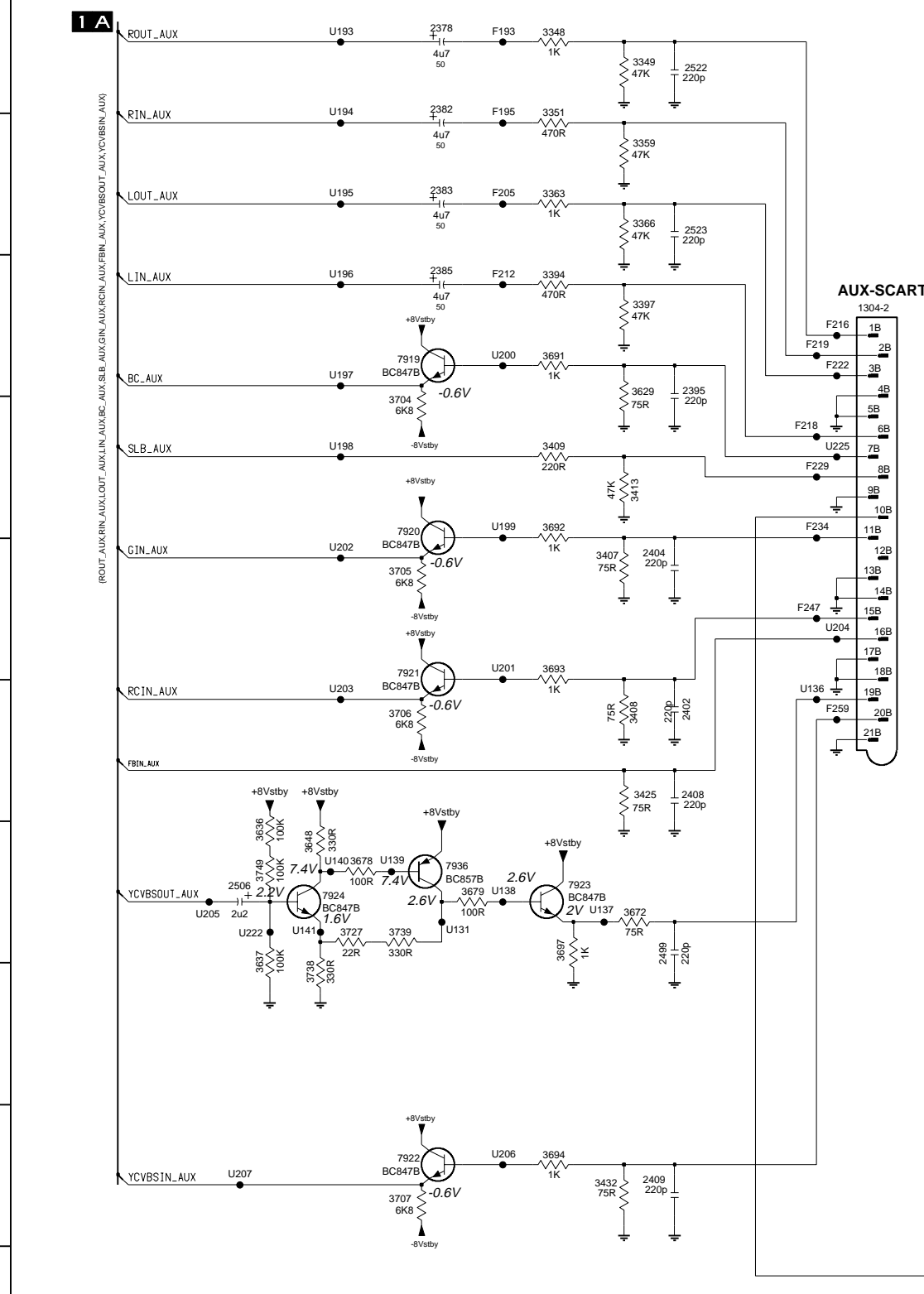

1A

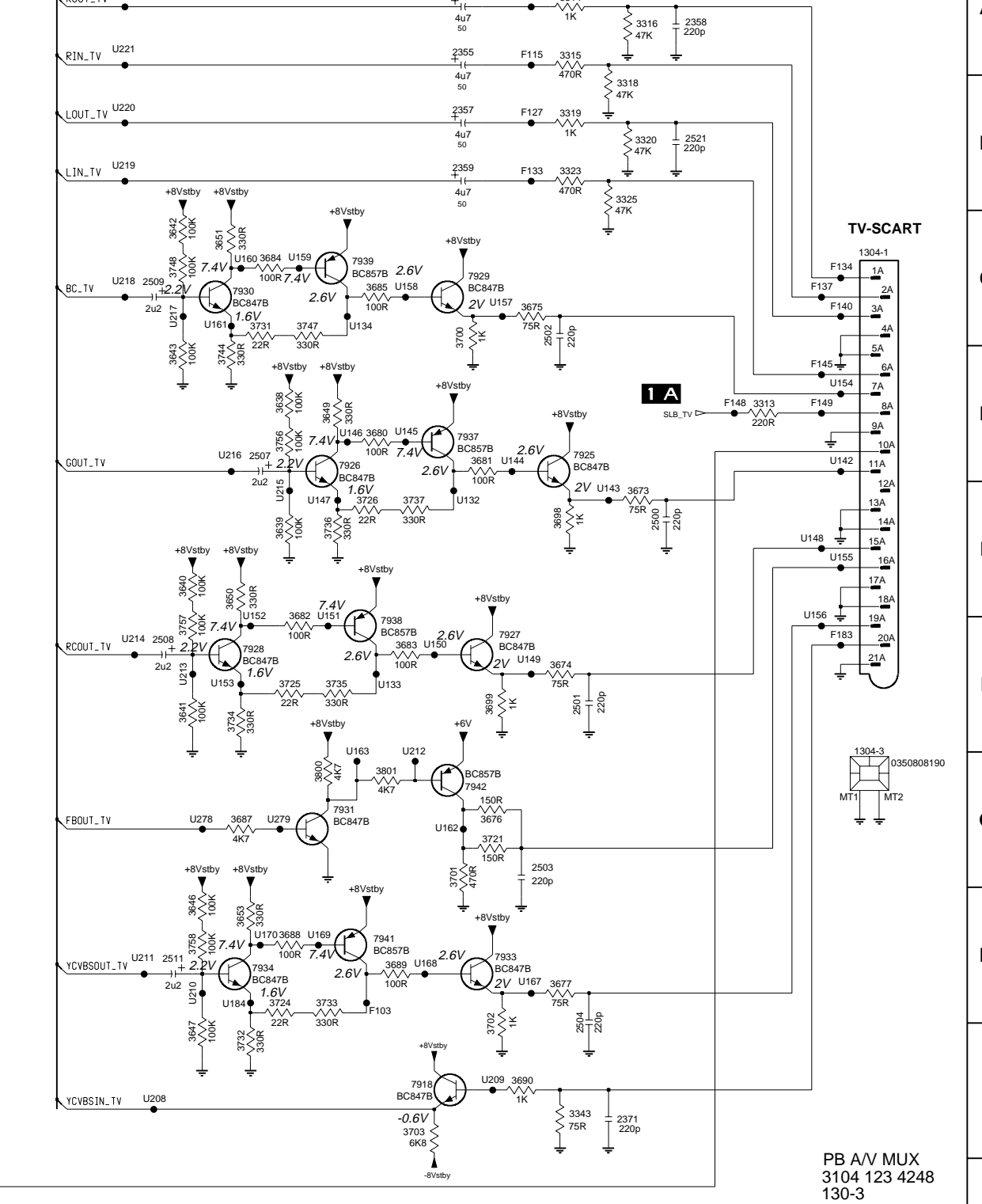

1304-1 C13	3737 E10	U214 F8
1304-2 C6	3738 H2	U215 D9
1304-3 G13	3739 G3	U216 D8
2353 A10	3744 D8	U217 C8
2355 A10	3747 C9	U218 C8
2357 B10	3748 C8	U219 B8
2358 A12	3749 G2	U220 B8
2359 B10	3756 D9	U221 A8
2371 I11	3757 F8	U222 G2
2378 A3	3758 H8	U223 A8
2382 A3	3800 G9	U225 D6
2383 B3	3801 G10	U278 G8
2385 C3	7918 I10	U279 G9
2395 C5	7919 C3	
2402 F5	7920 D3	
2404 E5	7921 E3	
2408 F5	7922 I3	
2409 I5	7923 G4	
2499 G5	7924 G2	
2500 E12	7925 D11	
2501 F11	7926 D9	
2502 C11	7927 F10	
2503 G11	7928 F9	
2504 H11	7929 C10	
2506 G2	7930 C8	
2507 D9	7931 G9	
2508 F8	7933 H10	
2509 C8	7934 H9	
2511 H8	7936 G3	
2521 B12	7937 D10	
2522 A5	7938 F10	
2523 B5	7939 F9	
3313 D12	7941 H9	
3314 A11	7942 G10	
3315 A11	F103 H10	
3316 A12	F114 A11	
3318 B11	F115 A11	
3319 B11	F127 B11	
3320 B12	F133 B11	
3323 B11	F134 C13	
3325 B11	F137 C13	
3343 H11	F140 C13	
3348 A4	F145 D13	
3349 A5	F148 D12	
3351 B4	F149 D13	
3359 B5	F183 F13	
3363 B4	F193 A4	
3366 B5	F195 B4	
3394 C4	F205 B4	
3397 C5	F212 C4	
3407 E5	F216 C6	
3408 F4	F218 D6	
3409 D4	F219 C6	
3413 D4	F222 C6	
3425 F5	F229 D6	
3432 I4	F234 D6	
3629 C5	F247 E6	
3636 G2	F259 F6	
3637 G2	U131 G3	
3638 D9	U132 E10	
3639 E9	U133 F10	
3640 E8	U134 C9	
3641 F8	U136 F6	
3642 C8	U137 G4	
3643 D8	U138 G4	
3646 H8	U139 G3	
3647 I8	U140 G2	
3648 G2	U141 G2	
3649 D9	U142 D13	
3650 E8	U143 E11	
3651 C8	U144 D11	
3653 H9	U145 D10	
3672 G5	U146 D9	
3673 E11	U147 E9	
3674 F11	U148 E13	
3675 C11	U149 F11	
3676 G10	U150 F10	
3677 H11	U151 F9	
3678 G3	U152 F9	
3679 G3	U153 F8	
3680 D10	U154 D13	
3681 D10	U155 E13	
3682 F9	U156 F13	
3683 F10	U157 C10	
3684 C9	U158 C10	
3685 C10	U159 C9	
3687 G9	U160 C9	
3688 H9	U161 C8	
3689 H10	U162 G10	
3690 I11	U163 G9	
3691 C4	U167 H11	
3692 D4	U168 H10	
3693 E4	U169 H9	
3694 I4	U170 H9	
3697 G4	U184 H8	
3698 E11	U193 A2	
3699 F10	U194 B2	
3700 C10	U195 B2	
3701 G10	U196 C2	
3702 I10	U197 C2	
3703 H10	U198 D2	
3704 D3	U199 D4	
3705 E3	U200 C4	
3706 F3	U201 E4	
3707 I3	U202 E2	
3721 G10	U203 F2	
3724 H9	U204 E6	
3725 F9	U205 G2	
3726 E9	U206 I4	
3727 G3	U207 I2	
3731 C9	U208 I8	
3732 I9	U209 I10	
3733 H9	U210 H8	
3734 H8	U211 H8	
3735 F9	U212 G10	
3736 E9	U213 F8	

SCHEMATIC DIAGRAM

A/V (B, G) 4/4

2B CVBS & YC

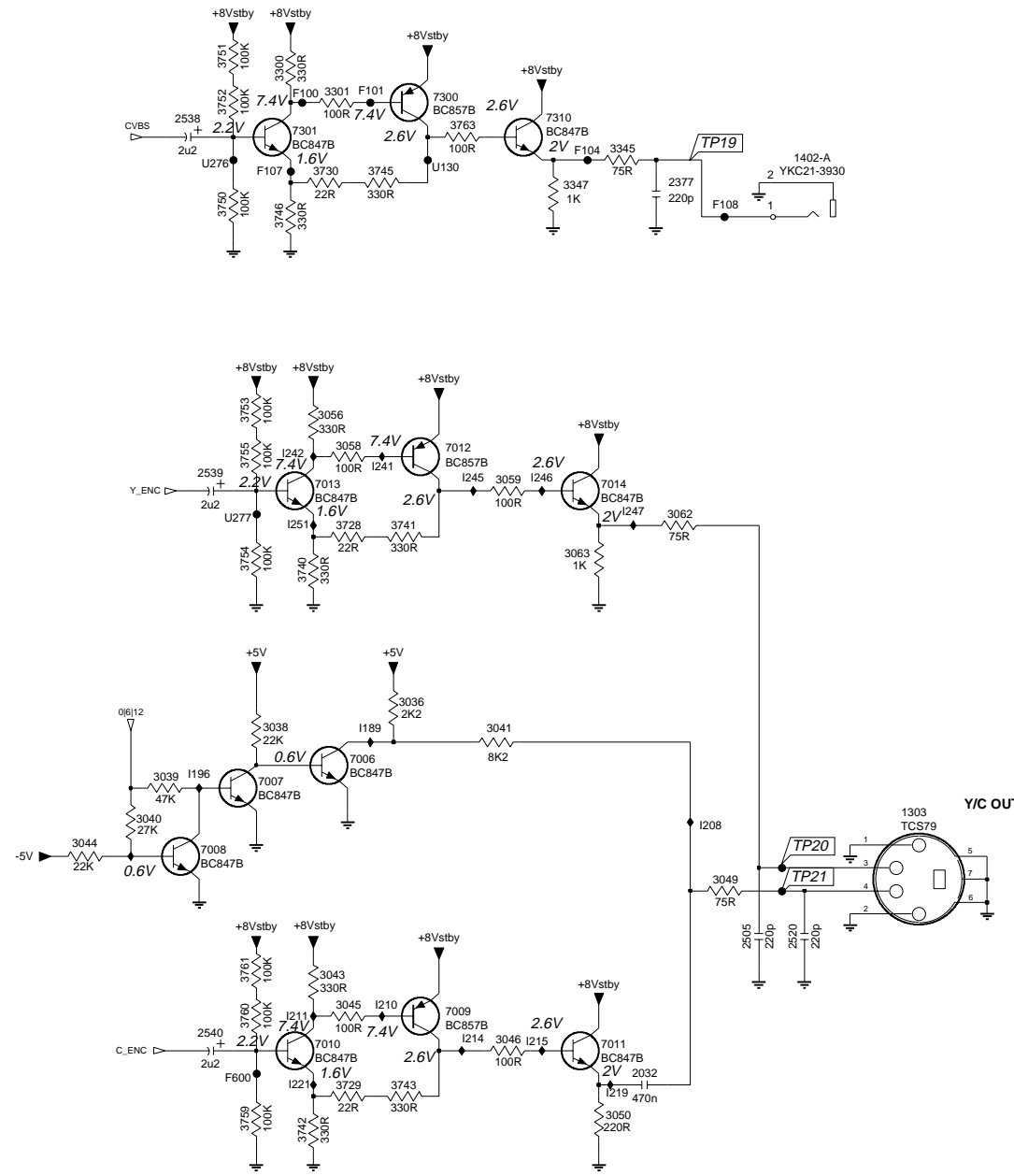

- 1303 F10
- 1402-A B9
- 2032 H8
- 2377 B9
- 2505 G9
- 2520 G9
- 2538 B5
- 2539 D6
- 2540 H6
- 3036 F7
- 3038 F6
- 3039 F5
- 3040 F5
- 3041 F7
- 3043 G6
- 3044 F5
- 3045 G6
- 3046 H7
- 3049 G9
- 3050 H8
- 3056 D6
- 3058 D6
- 3059 D7
- 3062 D9
- 3063 E8
- 3300 B6
- 3301 B6
- 3345 B8
- 3347 B8
- 3728 D6
- 3729 H6
- 3730 B6
- 3740 E6
- 3741 D7
- 3742 H6
- 3743 H7
- 3745 B7
- 3746 B6
- 3750 B6
- 3751 A6
- 3752 B6
- 3753 D6
- 3754 E6
- 3755 D6
- 3759 H6
- 3760 G6
- 3761 G6
- 3763 B7
- 3999 I1
- 7006 F6
- 7007 F6
- 7008 F6
- 7009 G7
- 7010 H6
- 7011 H8
- 7012 D7
- 7013 D6
- 7014 D8
- 7300 B7
- 7301 B6
- 7310 B8
- F100 B6
- F101 B7
- F104 B8
- F107 B6
- F108 B9
- F600 H6
- I189 F7
- I191 F6
- I196 F6
- I200 G5
- I208 F9
- I210 G7
- I211 G6
- I214 H7
- I215 H8
- I219 H6
- I221 H6
- I241 D7
- I242 D6
- I245 D7
- I246 D8
- I247 D8
- I251 D6
- U130 B7
- U192 G9
- U224 G9
- U276 B6
- U277 D6

PB A/V MUX
3104 123 4248
130-4

SCHEMATIC DIAGRAM DISPLAY

A1 : FRONT DISPLAY PCB

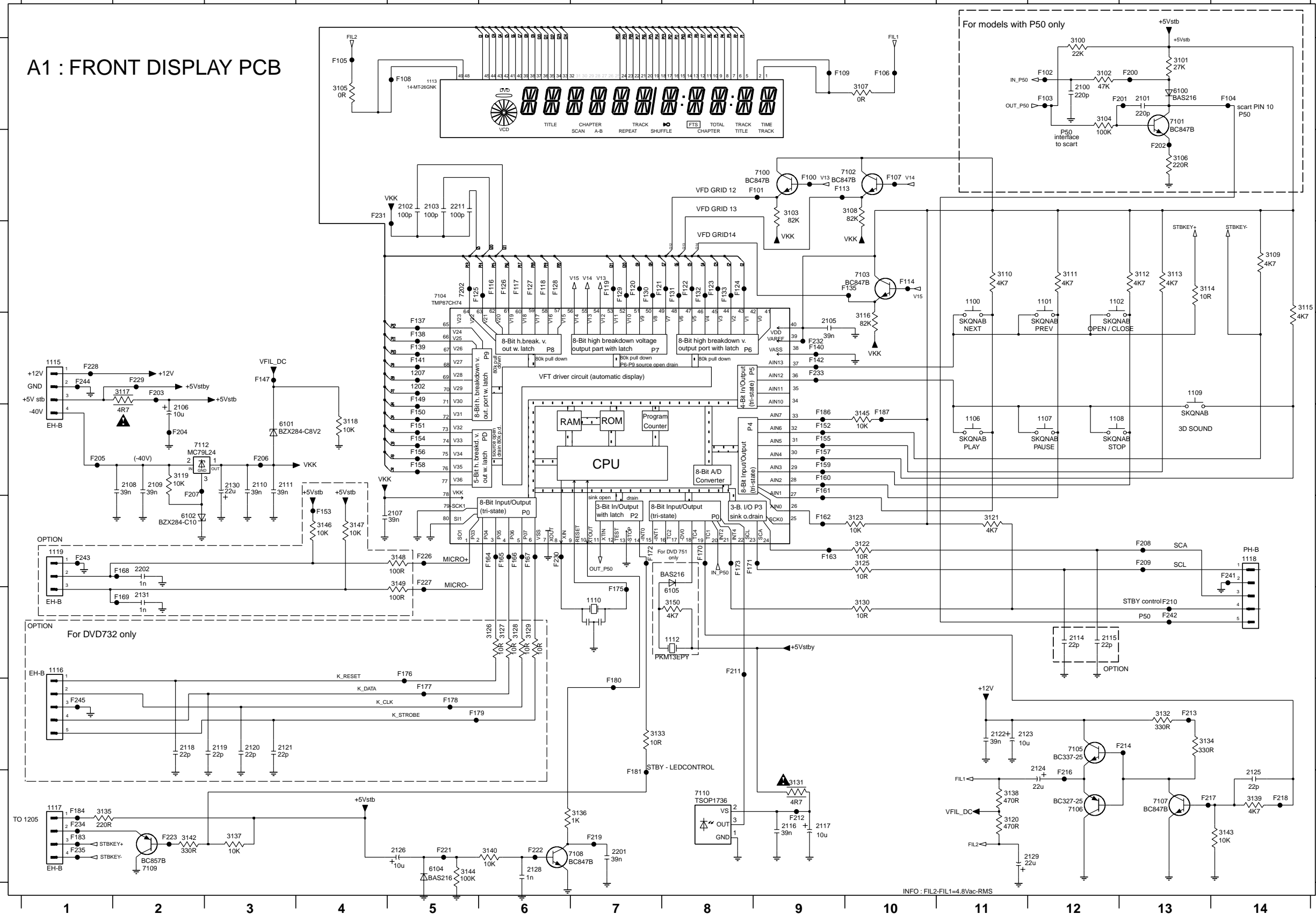

INFO : FIL2-FIL1=4.8Vac-RMS

SCHEMATIC DIAGRAM

POWER (B, G)

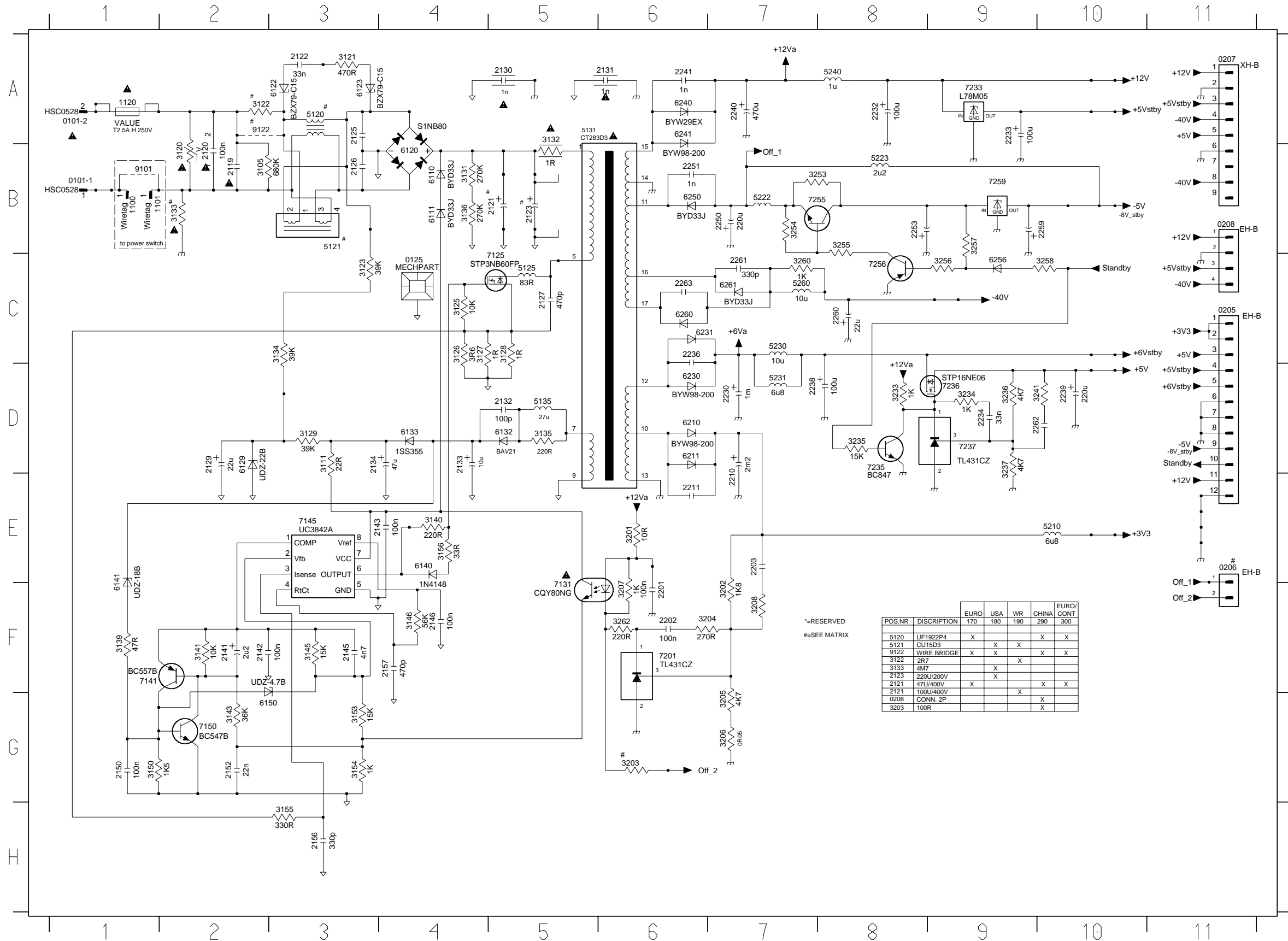

POS.NR	DISCRIPTION	EURO 170	USA 180	WR 190	CHINA 290	EURO/CONT 300
5120	UF1922P4	X			X	X
5121	CU15D3	X	X	X	X	X
9122	WIRE BRIDGE	X	X		X	X
3122	2R7			X		
3133	4M7		X			
2123	220U/200V		X			
2121	47U/400V	X	X		X	X
2121	100U/400V			X	X	
0206	CONN. 2P				X	
3203	100R				X	

*=RESERVED
#=SEE MATRIX

PARTS LIST

■ ELECTRICAL PARTS

■ WARNING

Components having special characteristics are marked \triangle and must be replaced with parts having specifications equal to those originally installed.

- For the parts No. of the chip carbon resistors, refer to last page of ELECTRICAL PARTS LIST.

ABBREVIATIONS IN THIS LIST ARE AS FOLLOWS:

C.A.EL.CHP	: CHIP ALUMI.ELECTROLYTIC CAP	L.EMIT	: LIGHT EMITTING MODULE
C.CE	: CERAMIC CAP	LED.DSPLY	: LED DISPLAY
C.CE.ARRAY	: CERAMIC CAP ARRAY	LED.INFRD	: LED,INFRARED
C.CE.CHP	: CHIP CERAMIC CAP	MODUL.RF	: MODULATOR,RF
C.CE.ML	: MULTILAYER CERAMIC CAP	PHOT.CPL	: PHOTO COUPLER
C.CE.M.CHP	: CHIP MULTILAYER CERAMIC CAP	PHOT.INTR	: PHOTO INTERRUPTER
C.CE.SAFTY	: RECOGNIZED CERAMIC CAP	PHOT.RFLCT	: PHOTO REFLECTOR
C.CE.TUBLR	: CERAMIC TUBULAR CAP	PIN.TEST	: PIN,TEST POINT
C.CE.SMI	: SEMI CONDUCTIVE CERAMIC CAP	PLST.RIVET	: PLASTIC RIVET
C.EL	: ELECTROLYTIC CAP	R.ARRAY	: RESISTOR ARRAY
C.MICA	: MICA CAP	R.CAR.	: CARBON RESISTOR
C.ML.FLM	: MULTILAYER FILM CAP	R.CAR.CHP	: CHIP RESISTOR
C.MP	: METALLIZED PAPER CAP	R.CAR.FP	: FLAME PROOF CARBON RESISTOR
C.MYLAR	: MYLAR FILM CAP	R.FUS	: FUSABLE RESISTOR
C.MYLAR.ML	: MULTILAYER MYLAR FILM CAP	R.MTL.CHP	: CHIP METAL FILM RESISTOR
C.PAPER	: PAPER CAPACITOR	R.MTL.FLM	: METAL FILM RESISTOR
C.PLS	: POLYSTYRENE FILM CAP	R.MTL.OXD	: METAL OXIDE FILM RESISTOR
C.POL	: POLYESTER FILM CAP	R.MTL.PLAT	: METAL PLATE RESISTOR
C.POLY	: POLYETHYLENE FILM CAP	RSNR.CE	: CERAMIC RESONATOR
C.PP	: POLYPROPYLENE FILM CAP	RSNR.CRYS	: CRYSTAL RESONATOR
C.TNTL	: TANTALUM CAP	R.TW.CEM	: TWIN CEMENT FIXED RESISTOR
C.TNTL.CHP	: CHIP TANTALUM CAP	R.WW	: WIRE WOUND RESISTOR
C.TRIM	: TRIMMER CAP	SCR.BND.HD	: BIND HEAD B-TITE SCREW
CN	: CONNECTOR	SCR.BW.HD	: BW HEAD TAPPING SCREW
CN.BS.PIN	: CONNECTOR,BASE PIN	SCR.CUP	: CUP TITE SCREW
CN.CANNON	: CONNECTOR,CANNON	SCR.TERM	: SCREW TERMINAL
CN.DIN	: CONNECTOR,DIN	SCR.TR	: SCREW,TRANSISTOR
CN.FLAT	: CONNECTOR,FLAT CABLE	SUPRT.PCB	: SUPPORT,P.C.B.
CN.POST	: CONNECTOR,BASE POST	SURG.PRTCT	: SURGE PROTECTOR
COIL.MX.AM	: COIL,AM MIX	SW.TACT	: TACT SWITCH
COIL.AT.FM	: COIL,FM ANTENNA	SW.LEAF	: LEAF SWITCH
COIL.DT.FM	: COIL,FM DETECT	SW.LEVER	: LEVER SWITCH
COIL.MX.FM	: COIL,FM MIX	SW.MICRO	: MICRO SWITCH
COIL.OUTPT	: OUTPUT COIL	SW.PUSH	: PUSH SWITCH
DIOD.ARRAY	: DIODE ARRAY	SW.RT.ENC	: ROTARY ENCODER
DIODE.BRG	: DIODE BRIDGE	SW.RT.MTR	: ROTARY SWITCH WITH MOTOR
DIODE.CHP	: CHIP DIODE	SW.RT	: ROTARY SWITCH
DIODE.VAR	: VARACTOR DIODE	SW.SLIDE	: SLIDE SWITCH
DIOD.Z.CHP	: CHIP ZENER DIODE	TERM.SP	: SPEAKER TERMINAL
DIODE.ZENR	: ZENER DIODE	TERM.WRAP	: WRAPPING TERMINAL
DSCR.CE	: CERAMIC DISCRIMINATOR	THRMST.CHP	: CHIP THERMISTOR
FER.BEAD	: FERRITE BEADS	TR.CHP	: CHIP TRANSISTOR
FER.CORE	: FERRITE CORE	TR.DGT	: DIGITAL TRANSISTOR
FET.CHP	: CHIP FET	TR.DGT.CHP	: CHIP DIGITAL TRANSISTOR
FL.DSPLY	: FLUORESCENT DISPLAY	TRANS	: TRANSFORMER
FLTR.CE	: CERAMIC FILTER	TRANS.PULS	: PULSE TRANSFORMER
FLTR.COMB	: COMB FILTER MODULE	TRANS.PWR	: POWER TRANSFORMER ASS'Y
FLTR.LC.RF	: LC FILTER,EMI	TUNER.AM	: TUNER PACK,AM
GND.MTL	: GROUND PLATE	TUNER.FM	: TUNER PACK,FM
GND.TERM	: GROUND TERMINAL	TUNER.PK	: FRONT-END TUNER PACK
HOLDER.FUS	: FUSE HOLDER	VR	: ROTARY POTENTIOMETER
IC.PRTCT	: IC PROTECTOR	VR.MTR	: POTENTIOMETER WITH MOTOR
JUMPER.CN	: JUMPER CONNECTOR	VR.SW	: POTENTIOMETER WITH ROTARY SW
JUMPER.TST	: JUMPER,TEST POINT	VR.SLIDE	: SLIDE POTENTIOMETER
L.DTCT	: LIGHT DETECTING MODULE	VR.TRIM	: TRIMMER POTENTIOMETER

Note) Those parts marked with “#” are not included in the P.C.B. ass'y.

P. C. B. MONO

Schm Ref.	PART NO.	Description	Remarks
	AAX21950	P. C. B.	MONO (UCART)
	AAX21940	P. C. B.	MONO (GB)
1104	AAX22180	CON	BMH 24P FFC
1106	AAX22190	CON	BMH 8P FFC
1205	AAX23320	RSNR. CRYST	8.467MHz
1300	AAX23310	RSNR. CRYST	6MHz
1301	AAX22360	CON	11P FEMALE
1603	AAX22210	CON	BMV 22P FFC
1604	AAX22200	CON	BMV 16P FFC
2100	US135100	C. CE. CHP	0.1uF 16V
2101	US135100	C. CE. CHP	0.1uF 16V
2103	UF037470	C. EL. CHP	47uF 16V
2104	US063470	C. CE. CHP	4700pF 50V
2105	US061220	C. CE. CHP	22pF 50V
2107	US061680	C. CE. CHP	68PF 50V
2108	US062390	C. CE. CHP	390PF 50V
2110	US063220	C. CE. CHP	2200pF 50V
2111	US135100	C. CE. CHP	0.1uF 16V
2112	US063100	C. CE. CHP	1000pF 50V
2113	US135100	C. CE. CHP	0.1uF 16V
2114	US062100	C. CE. CHP	100pF 50V
2115	US135100	C. CE. CHP	0.1uF 16V
2116	US135100	C. CE. CHP	0.1uF 16V
2117	US135100	C. CE. CHP	0.1uF 16V
2120	US135100	C. CE. CHP	0.1uF 16V
2121	US135220	C. CE. CHP	0.22uF 16V
2123	US135100	C. CE. CHP	0.1uF 16V
2124	US135100	C. CE. CHP	0.1uF 16V
2125	US135100	C. CE. CHP	0.1uF 16V
2126	US135100	C. CE. CHP	0.1uF 16V
2127	US135100	C. CE. CHP	0.1uF 16V
2128	US062180	C. CE. CHP	180pF 50V
2129	US062180	C. CE. CHP	180pF 50V
2130	US061220	C. CE. CHP	22pF 50V
2131	US044220	C. CE. CHP	0.022uF 25V
2136	US135100	C. CE. CHP	0.1uF 16V
2137	US135100	C. CE. CHP	0.1uF 16V
2138	US135100	C. CE. CHP	0.1uF 16V
2139	US135100	C. CE. CHP	0.1uF 16V
2140	US062330	C. CE. CHP	330P 50V
2141	US061220	C. CE. CHP	22pF 50V
2142	US064100	C. CE. CHP	0.01uF 50V
2143	US062220	C. CE. CHP	220pF 50V
2144	US062220	C. CE. CHP	220pF 50V
2145	US062220	C. CE. CHP	220pF 50V
2203	US135100	C. CE. CHP	0.1uF 16V
2204	US135100	C. CE. CHP	0.1uF 16V
2205	US135100	C. CE. CHP	0.1uF 16V
2206	US034330	C. CE. CHP	0.033uF 16V
2207	US063100	C. CE. CHP	1000pF 50V
2208	US135100	C. CE. CHP	0.1uF 16V
2209	US135100	C. CE. CHP	0.1uF 16V
2210	US063100	C. CE. CHP	1000pF 50V
2212	US135100	C. CE. CHP	0.1uF 16V
2213	US135100	C. CE. CHP	0.1uF 16V
2215	UF017220	C. EL. CHP	22uF 6.3V
2216	US063100	C. CE. CHP	1000pF 50V
2226	US135100	C. CE. CHP	0.1uF 16V
2227	US135100	C. CE. CHP	0.1uF 16V
2228	US135100	C. CE. CHP	0.1uF 16V
2300	US135100	C. CE. CHP	0.1uF 16V
2301	US135100	C. CE. CHP	0.1uF 16V
2302	US135100	C. CE. CHP	0.1uF 16V

* New Parts

Schm Ref.	PART NO.	Description	Remarks
2303	UF017470	C. EL. CHP	47uF 6.3V
2306	UF037100	C. EL. CHP	10uF 16V
2309	US135100	C. CE. CHP	0.1uF 16V
2310	US135100	C. CE. CHP	0.1uF 16V
2314	US135100	C. CE. CHP	0.1uF 16V
2315	US135100	C. CE. CHP	0.1uF 16V
2318	US062120	C. CE. CHP	120PF 50V
2319	US061270	C. CE. CHP	27PF 50V
2401	US135100	C. CE. CHP	0.1uF 16V
2402	US135100	C. CE. CHP	0.1uF 16V
2403	US135100	C. CE. CHP	0.1uF 16V
2404	US135100	C. CE. CHP	0.1uF 16V
2405	US135100	C. CE. CHP	0.1uF 16V
2406	US135100	C. CE. CHP	0.1uF 16V
2407	US135100	C. CE. CHP	0.1uF 16V
2408	US135100	C. CE. CHP	0.1uF 16V
2409	US135100	C. CE. CHP	0.1uF 16V
2410	US135100	C. CE. CHP	0.1uF 16V
2411	US135100	C. CE. CHP	0.1uF 16V
2412	US135100	C. CE. CHP	0.1uF 16V
2413	US135100	C. CE. CHP	0.1uF 16V
2418	UF038100	C. EL. CHP	100uF 16V
2419	UF017470	C. EL. CHP	47uF 6.3V
2420	UF017470	C. EL. CHP	47uF 6.3V
2500	US135100	C. CE. CHP	0.1uF 16V
2502	UF066470	C. EL. CHP	4.7uF 50V
2503	US135100	C. CE. CHP	0.1uF 16V
2504	US062100	C. CE. CHP	100pF 50V
2505	US044220	C. CE. CHP	0.022uF 25V
2506	UF037100	C. EL. CHP	10uF 16V
2507	US135100	C. CE. CHP	0.1uF 16V
2508	US063330	C. CE. CHP	3300pF 50V
2509	US062330	C. CE. CHP	330P 50V
2510	US135100	C. CE. CHP	0.1uF 16V
2511	US135100	C. CE. CHP	0.1uF 16V
2512	US135100	C. CE. CHP	0.1uF 16V
2513	US135100	C. CE. CHP	0.1uF 16V
2514	US135100	C. CE. CHP	0.1uF 16V
2515	US135100	C. CE. CHP	0.1uF 16V
2516	US135100	C. CE. CHP	0.1uF 16V
2517	US135100	C. CE. CHP	0.1uF 16V
2518	US135100	C. CE. CHP	0.1uF 16V
2519	US135100	C. CE. CHP	0.1uF 16V
2520	US135100	C. CE. CHP	0.1uF 16V
2521	US135100	C. CE. CHP	0.1uF 16V
2522	US135100	C. CE. CHP	0.1uF 16V
2523	US135100	C. CE. CHP	0.1uF 16V
2524	US135100	C. CE. CHP	0.1uF 16V
2525	US135100	C. CE. CHP	0.1uF 16V
2526	US135100	C. CE. CHP	0.1uF 16V
2527	US135100	C. CE. CHP	0.1uF 16V
2528	US135100	C. CE. CHP	0.1uF 16V
2529	US135100	C. CE. CHP	0.1uF 16V
2530	UF066470	C. EL. CHP	4.7uF 50V
2531	UF066470	C. EL. CHP	4.7uF 50V
2532	US061470	C. CE. CHP	47pF 50V
2533	US061470	C. CE. CHP	47pF 50V
2534	US063100	C. CE. CHP	1000pF 50V
2535	US063100	C. CE. CHP	1000pF 50V
2600	US044220	C. CE. CHP	0.022uF 25V
2601	US063150	C. CE. CHP	1500pF 50V
2602	US063150	C. CE. CHP	1500pF 50V
2603	US135100	C. CE. CHP	0.1uF 16V

* New Parts

P. C. B. MONO

Schm Ref.	PART NO.	Description	Remarks
* 2604	UF038100	C. EL. CHP 100uF 16V	4822 124 12095
* 2605	US044220	C. CE. CHP 0.022uF 25V	4822 126 14494
* 2606	UF038100	C. EL. CHP 100uF 16V	4822 124 12095
* 2607	UF038100	C. EL. CHP 100uF 16V	4822 124 12095
* 2608	UF037100	C. EL. CHP 10uF 16V	4822 124 23002
* 2609	UF037470	C. EL. CHP 47uF 16V	4822 124 80151
* 2610	US135100	C. CE. CHP 0.1uF 16V	4822 126 14305
* 2611	UF038100	C. EL. CHP 100uF 16V	4822 124 12095
* 2614	US061470	C. CE. CHP 47pF 50V	4822 122 33777
* 2615	US061470	C. CE. CHP 47pF 50V	4822 122 33777
* 2616	US061470	C. CE. CHP 47pF 50V	4822 122 33777
* 2617	US061470	C. CE. CHP 47pF 50V	4822 122 33777
* 2618	US135100	C. CE. CHP 0.1uF 16V	4822 126 14305
* 2620	US061470	C. CE. CHP 47pF 50V	4822 122 33777
* 2621	US061470	C. CE. CHP 47pF 50V	4822 122 33777
* 2622	US061470	C. CE. CHP 47pF 50V	4822 122 33777
* 2623	US061470	C. CE. CHP 47pF 50V	4822 122 33777
* 2624	US061470	C. CE. CHP 47pF 50V	4822 122 33777
* 2625	US061470	C. CE. CHP 47pF 50V	4822 122 33777
* 2626	US061470	C. CE. CHP 47pF 50V	4822 122 33777
* 2627	US061470	C. CE. CHP 47pF 50V	4822 122 33777
* 2632	UF038100	C. EL. CHP 100uF 16V	4822 124 12095
* 2633	UF038100	C. EL. CHP 100uF 16V	4822 124 12095
* 2634	US135100	C. CE. CHP 0.1uF 16V	4822 126 14305
* 2635	US135100	C. CE. CHP 0.1uF 16V	4822 126 14305
* 2636	US135100	C. CE. CHP 0.1uF 16V	4822 126 14305
* 2637	US135100	C. CE. CHP 0.1uF 16V	4822 126 14305
* 2638	US135100	C. CE. CHP 0.1uF 16V	4822 126 14305
* 2639	US135100	C. CE. CHP 0.1uF 16V	4822 126 14305
* 3102	HX609900	R. MTL. CHP 1.5K 1/16W	5322 117 13034
* 3103	HX609900	R. MTL. CHP 1.5K 1/16W	5322 117 13034
* 3104	HX609170	R. MTL. CHP 390 1/10W	5322 117 13062
* 3112	HX609650	R. MTL. CHP 47K 1/10W	5322 117 13021
* 3116	NX703350	R. MTL. CHP 3.9K 1/10W	5322 117 13042
* 3119	HX609170	R. MTL. CHP 390 1/10W	5322 117 13062
* 3134	HX609160	R. MTL. CHP 330 1/10W	5322 117 13047
* 3138	HX609950	R. MTL. CHP 6.8K 1/10W	5322 117 13053
* 3142	HX610290	R. MTL. CHP 12K 1/10W	5322 117 13028
* 3143	HX609140	R. MTL. CHP 220 1/10W	5322 117 13043
* 3148	HX610120	R. MTL. CHP 22K 1/16W	5322 117 13022
* 3158	HX609660	R. MTL. CHP 100K 1/10W	5322 117 13017
* 3165	Vi192600	R. MTL. CHP 120 1/10W	5322 117 13063
* 3168	HX609160	R. MTL. CHP 330 1/10W	5322 117 13047
* 3172	HX609660	R. MTL. CHP 100K 1/10W	4822 117 13632
* 3173	HX609660	R. MTL. CHP 100K 1/10W	4822 117 13632
* 3180	HX609660	R. MTL. CHP 100K 1/10W	4822 117 13632
* 3182	HX609640	R. MTL. CHP 1K 1/10W	5322 117 13018
* 3183	HX609660	R. MTL. CHP 100K 1/10W	5322 117 13017
* 3198	HX609180	R. MTL. CHP 470 1/10W	5322 117 13049
* 3199	NX703350	R. MTL. CHP 3.9K 1/10W	5322 117 13042
* 3234	HX610400	R. MTL. CHP 8.2K 1/10W	4822 117 12902
* 3235	HX609660	R. MTL. CHP 100K 1/10W	4822 117 13632
* 3322	HX609950	R. MTL. CHP 4.7K 1/10W	5322 117 13026
* 3323	HX609950	R. MTL. CHP 4.7K 1/10W	5322 117 13026
* 3324	HX609660	R. MTL. CHP 100K 1/10W	4822 117 13632
* 3606	HX609650	R. MTL. CHP 47K 1/10W	4822 117 12925
* 3607	HX609660	R. MTL. CHP 100K 1/10W	4822 117 13632
* 3608	HX609660	R. MTL. CHP 100K 1/10W	4822 117 13632
* 3609	HX609660	R. MTL. CHP 100K 1/10W	4822 117 13632
* 3693	HX609650	R. MTL. CHP 47K 1/10W	4822 117 12925
* 5200	AAX22070	COIL BLM31P500SPT	4822 157 11717
* 5300	AAX22070	COIL BLM31P500SPT	4822 157 11717
* 5301	AAX22070	COIL BLM31P500SPT	4822 157 11717

* New Parts

Schm Ref.	PART NO.	Description	Remarks
* 5402	AAX22050	COIL BLM11P600SPT	4822 157 11499
* 5403	AAX22050	COIL BLM11P600SPT	4822 157 11499
* 5501	AAX22110	COIL 2.2uH NL322522T	4822 157 70299
* 5502	AAX22110	COIL 2.2uH NL322522T	4822 157 70299
* 5503	AAX22130	COIL BLM21A601SPT	4822 157 71206
* 5504	AAX22130	COIL BLM21A601SPT	4822 157 71206
* 5600	AAX22130	COIL BLM21A601SPT	4822 157 71206
* 5601	AAX22050	COIL BLM11P600SPT	4822 157 11499
* 5602	AAX22030	COIL 15uH	4822 157 10547
* 5603	AAX22130	COIL BLM21A601SPT	4822 157 71206
* 5604	AAX22030	COIL 15uH	4822 157 10547
* 5605	AAX22030	COIL 15uH	4822 157 10547
* 5606	AAX22030	COIL 15uH	4822 157 10547
* 5607	AAX22030	COIL 15uH	4822 157 10547
* 5608	AAX22030	COIL 15uH	4822 157 10547
* 5609	AAX22070	COIL BLM31P500SPT	4822 157 11717
* 5610	AAX22070	COIL BLM31P500SPT	4822 157 11717
* 6200	AAX22630	DIODE. CHP BAS316	4822 130 11397
* 6301	AAX22690	DIODE. CHP S1D	9322 128 69685
* 6302	AAX22690	DIODE. CHP S1D	9322 128 69685
* 6303	AAX22690	DIODE. CHP S1D	9322 128 69685
* 6600	AAX22650	DIODE. CHP 1PS76SB10	4822 130 11528
* 7100	AAX22750	TR. CHP BFS20	5322 130 42718
* 7101	AAX22750	TR. CHP BFS20	5322 130 42718
* 7102	AAX21880	IC TZA1033HL	9352 637 37518
* 7103	AAX21620	IC BA5938FM	4822 209 17229
* 7104	AAX21660	IC LM833D	4822 209 30095
* 7105	AAX21690	IC MC34072D	4822 209 32073
* 7106	AAX22750	TR. CHP BFS20	5322 130 42718
* 7109	AAX21580	IC AN78M09	4822 209 15083
* 7110	AAX22760	TR. CHP BST72A	5322 130 60803
* 7111	AAX22740	TR. CHP BC847B	4822 130 60511
* 7112	AAX22740	TR. CHP BC847B	4822 130 60511
* 7113	AAX22740	TR. CHP BC847B	4822 130 60511
* 7114	AAX22740	TR. CHP BC847B	4822 130 60511
* 7115	AAX22730	TR. CHP BC856B	4822 130 60373
* 7116	AAX22740	TR. CHP BC847B	4822 130 60511
* 7201	AAX21860	IC 74HCT573	9351 869 80118
* 7202	AAX21550	IC M29F002	3104 123 95660
* 7203	AAX22730	TR. CHP BC856B	4822 130 60373
* 7207	AAX21870	IC SAA7399HL/M2A	9352 636 60557
* 7208	AAX21780	IC MC33464N-45A	9322 139 67685
* 7304	AAX21600	IC BA6856FP	4822 209 16877
* 7310	AAX21590	IC CY7C199-15C	4822 209 15899
* 7311	AAX21890	IC SAA7335HL/E/M2	9352 637 83557
* 7312	AAX22730	TR. CHP BC856B	4822 130 60373
* 7315	AAX22740	TR. CHP BC847B	4822 130 60511
* 7401	AAX21520	IC AM29LV160BT-90SC	3104 123 85540
* 7404	AAX21800	IC MT48LC1M16A1TG-7S	9322 144 59668
* 7405	AAX21800	IC MT48LC1M16A1TG-7S	9322 144 59668
* 7501	AAX22740	TR. CHP BC847B	4822 130 60511
* 7503	AAX21810	IC ST15505EVB	9322 144 88671
* 7503	AAX21830	IC ST15505AVC	9322 151 16671
* 7504	AAX23460	RSNR. CRYST 27MHZ 120P FX0-31F	4822 242 10838
* 7505	AAX21850	IC M24C32-WMN6TNKSA	9322 156 81668
* 7505	AAX21760	IC M24C32-WMN6TNKSA	8204 056 05580
* 7600	AAX21740	IC PC74HCT14T	5322 209 71568
* 7604	AAX22740	TR. CHP BC847B	4822 130 60511
* 7605	AAX21630	IC LD1117DT33	4822 209 17398
* 7607	AAX22740	TR. CHP BC847B	4822 130 60511
* 7608	AAX22730	TR. CHP BC856B	4822 130 60373
* 7609	AAX22730	TR. CHP BC856B	4822 130 60373
* 7610	AAX22740	TR. CHP BC847B	4822 130 60511

* New Parts

P. C. B. MONO & P. C. B. A/V

Schm Ref.	PART NO.	Description	Remarks
* 7612	AAX22740	TR. CHP BC847B	4822 130 60511
* 7613	AAX22740	TR. CHP BC847B	4822 130 60511
* 7614	AAX22740	TR. CHP BC847B	4822 130 60511
* 7615	AAX22740	TR. CHP BC847B	4822 130 60511
* 7616	AAX21840	IC SM MK2703STR	9322 151 71668
* 7617	AAX22740	TR. CHP BC847B	4822 130 60511
* 7618	AAX22740	TR. CHP BC847B	4822 130 60511
* 7620	AAX22730	TR. CHP BC856B	4822 130 60373
* 7621	AAX22780	TR. CHP BC817-25	4822 130 42804
* 7622	AAX22740	TR. CHP BC847B	4822 130 60511
* 1000	AAX21930	P. C. B. AV(UCART)	3139 248 80591
* 1001	AAX22220	CN BMV 16P FFC	2422 025 16525
* 1003	AAX22230	CN BMV 22P FFC	2422 025 16526
* 1003	AAX22350	CN 4P MDIN	4822 267 10994
* 1006	AAX22250	CN BM 3P F	2422 026 05049
* 1008	AAX22240	CN BM 6P F	2422 026 05047
2001	UR837220	C. EL 22uF 16V	
2002	UR848100	C. EL 100uF 25V	
2004	UR848100	C. EL 100uF 25V	
* 2007	UB445470	C. CE. M. CHP 0.47uF 16V	
2008	UR838100	C. EL 100uF 16V	
2009	US062220	C. CE. CHP 220pF 50V	
2010	US062220	C. CE. CHP 220pF 50V	
2012	US044220	C. CE. CHP 0.022uF 25V	
2013	US044220	C. CE. CHP 0.022uF 25V	
2016	UR848100	C. EL 100uF 25V	
2200	UR848100	C. EL 100uF 25V	
* 2201	UB445100	C. CE. M. CHP 0.1uF 16V	
2202	UR837100	C. EL 10uF 16V	
2203	UR838100	C. EL 100uF 16V	
2204	UR848100	C. EL 100uF 25V	
2205	UR838100	C. EL 100uF 16V	
* 2206	UB445100	C. CE. M. CHP 0.1uF 16V	
2207	UR837470	C. EL 47uF 16V	
* 2208	UB445100	C. CE. M. CHP 0.1uF 16V	
* 2209	UB445100	C. CE. M. CHP 0.1uF 16V	
2210	UR837470	C. EL 47uF 16V	
* 2211	UB445100	C. CE. M. CHP 0.1uF 16V	
2212	US063100	C. CE. CHP 1000pF 50V	
2213	US063100	C. CE. CHP 1000pF 50V	
2214	UR837100	C. EL 10uF 16V	
2215	UR838100	C. EL 100uF 16V	
2216	UR837100	C. EL 10uF 16V	
* 2217	UB445470	C. CE. M. CHP 0.47uF 16V	
2221	US063100	C. CE. CHP 1000pF 50V	
2222	US063100	C. CE. CHP 1000pF 50V	
2224	US063100	C. CE. CHP 1000pF 50V	
2225	UR837100	C. EL 10uF 16V	
2226	US061470	C. CE. M. CHP 47pF 50V	
* 2227	UB445100	C. CE. M. CHP 0.1uF 16V	
2228	US061470	C. CE. M. CHP 47pF 50V	
2229	US062100	C. CE. CHP 100pF 50V	
2230	US062100	C. CE. CHP 100pF 50V	
2231	UR838470	C. EL 470uF 16V	
* 3016	Vi194500	R. MTL. CHP 680 1/10W	5322 117 13051
* 3017	HX610400	R. MTL. CHP 8.2K 1/16W	4822 117 12902
* 3035	Vi194500	R. MTL. CHP 680 1/10	5322 117 13051
* 3040	HX610110	R. MTL. CHP 2.2K 1/16W	4822 050 12202
* 3041	HX609930	R. MTL. CHP 3.3K 1/10W	5322 117 13048
* 3042	HX609960	R. MTL. CHP 6.8K 1/16W	5322 117 13053

* New Parts

Schm Ref.	PART NO.	Description	Remarks
* 3046	HX609640	R. MTL. CHP 1K 1/10W	4822 117 13611
* 3047	HX609640	R. MTL. CHP 1K 1/10W	4822 117 13611
* 3050	HX609900	R. MTL. CHP 1.5K 1/16W	5322 117 13034
* 3053	HX609640	R. MTL. CHP 1K 1/10W	4822 117 13611
* 3054	HX609640	R. MTL. CHP 1K 1/10W	4822 117 13611
* 3055	HX609640	R. MTL. CHP 1K 1/10W	4822 117 13611
* 3057	HX610030	R. MTL. CHP 1.2K 1/10W	5322 117 13036
* 3060	HX609640	R. MTL. CHP 1K 1/10W	4822 117 13611
* 3061	HX609960	R. MTL. CHP 6.8K 1/16W	5322 117 13053
* 3208	HX610400	R. MTL. CHP 8.2K 1/16W	4822 117 12902
* 3210	HX609950	R. MTL. CHP 4.7K 1/10W	5322 117 13026
* 3216	HX610400	R. MTL. CHP 8.2K 1/16W	4822 117 12902
* 3218	HX609950	R. MTL. CHP 4.7K 1/10W	5322 117 13026
* 3231	HX609130	R. MTL. CHP 100K 1/10W	4822 117 13632
* 5003	AAX22140	COIL DSS306	4822 242 10756
* 5004	AAX22140	COIL DSS306	4822 242 10756
* 5005	AAX22140	COIL DSS306	4822 242 10756
* 5006	AAX22140	COIL DSS306	4822 242 10756
* 5007	AAX22140	COIL DSS306	4822 242 10756
* 5008	AAX22120	COIL 100uH	4822 157 70601
* 6000	AAX22670	DIODE. CHP 1SS355	4822 130 83649
* 6001	AAX22670	DIODE. CHP 1SS355	4822 130 83649
* 6002	AAX22640	DIODE. CHP UDZ15B	4822 130 11522
* 6003	AAX22640	DIODE. CHP UDZ15B	4822 130 11522
* 6004	AAX22640	DIODE. CHP UDZ15B	4822 130 11522
* 6005	AAX22640	DIODE. CHP UDZ15B	4822 130 11522
* 6006	AAX22640	DIODE. CHP UDZ15B	4822 130 11522
* 6007	AAX22640	DIODE. CHP UDZ15B	4822 130 11522
* 6008	AAX22640	DIODE. CHP UDZ15B	4822 130 11522
* 7001	AAX21790	IC AD8073	9322 141 80668
* 7002	AAX21700	IC L7905CV	4822 209 72684
* 7010	AAX21610	IC LF33CV	4822 209 16978
* 7011	AAX21900	IC UDA1334TS/NI	9352 640 74118
* 7012	AAX21660	IC LM833D	4822 209 30095
* 7028	AAX22270	CN GP1F32T	4822 130 10845
* 7400	AAX22740	TR. CHP BC847B	4822 130 60511
* 7403	AAX22730	TR. CHP BC856B	4822 130 60373
* 7404	AAX22740	TR. CHP BC847B	4822 130 60511
* 7405	AAX22740	TR. CHP BC847B	4822 130 60511
* 7406	AAX22740	TR. CHP BC847B	4822 130 60511
* 7407	AAX22740	TR. CHP BC847B	4822 130 60511
* 7408	AAX22730	TR. CHP BC856B	4822 130 60373
* 7409	AAX22780	TR. CHP BC817-25	4822 130 42804
* 7410	AAX22740	TR. CHP BC847B	4822 130 60511
* 7411	AAX22740	TR. CHP BC847B	4822 130 60511
* 7412	AAX22730	TR. CHP BC856B	4822 130 60373
* 7413	AAX22740	TR. CHP BC847B	4822 130 60511
* 7414	AAX22740	TR. CHP BC847B	4822 130 60511
* 7415	AAX22740	TR. CHP BC847B	4822 130 60511
* 7451	AAX22780	TR. CHP BC817-25	4822 130 42804
* 7452	AAX22780	TR. CHP BC817-25	4822 130 42804
* 7453	AAX22780	TR. CHP BC817-25	4822 130 42804
* 7454	AAX22780	TR. CHP BC817-25	4822 130 42804
* 7455	AAX22740	TR. CHP BC847B	4822 130 60511
* 7456	AAX22780	TR. CHP BC817-25	4822 130 42804
* 7457	AAX22740	TR. CHP BC847B	4822 130 60511
* 7458	AAX22730	TR. CHP BC856B	4822 130 60373
* 1300	AAX22290	CN 22P(52030-2210)	4822 265 11154
* 1301	AAX22280	CN 16P(52030-1610)	4822 265 11103
* 1301	AAX21920	P. C. B. AV(GB)	3104 128 06121

* New Parts

P. C. B. A/V

Schm Ref.	PART NO.	Description	Remarks	Schm Ref.	PART NO.	Description	Remarks
* 1303	AAX22350	CN 4P MD1N	4822 267 10994	2521	US062220	C. CE. CHP 220pF 50V	
* 1304	AAX22260	CN BM EURO H 42P	2422 033 00334	2522	US062220	C. CE. CHP 220pF 50V	
* 1402	AAX22300	CN 3P YKC21-3930	4822 265 11566	2523	US062220	C. CE. CHP 220pF 50V	
* 1410	AAX22310	CN B7B-EH-A	2422 025 11244	* 2524	UB245220	C. CE. M. CHP 0.22uF 25V	
* 2032	UB445470	C. CE. M. CHP 0.47uF 16V		* 2525	UB245220	C. CE. M. CHP 0.22uF 25V	
* 2353	UR896470	C. EL 4.7uF 100V		2527	UB044220	C. CE. M. CHP 0.022uF 50V	
* 2354	UB245220	C. CE. M. CHP 0.22uF 25V		2528	UB044220	C. CE. M. CHP 0.022uF 50V	
* 2355	UR896470	C. EL 4.7uF 100V		2529	UB044220	C. CE. M. CHP 0.022uF 50V	
* 2357	UR896470	C. EL 4.7uF 100V		2530	UB044220	C. CE. M. CHP 0.022uF 50V	
* 2358	US062220	C. CE. CHP 220pF 50V		2531	UB044220	C. CE. M. CHP 0.022uF 50V	
* 2359	UR896470	C. EL 4.7uF 100V		2532	UB044220	C. CE. M. CHP 0.022uF 50V	
* 2360	US061470	C. CE. CHP 47pF 50V		2533	UB044220	C. CE. M. CHP 0.022uF 50V	
* 2361	US061470	C. CE. CHP 47pF 50V		2534	UB044220	C. CE. M. CHP 0.022uF 50V	
* 2371	US062220	C. CE. CHP 220pF 50V		2535	UB044220	C. CE. M. CHP 0.022uF 50V	
* 2372	UR896470	C. EL 4.7uF 100V		2536	UB044220	C. CE. M. CHP 0.022uF 50V	
* 2373	UR896470	C. EL 4.7uF 100V		2537	UB044220	C. CE. M. CHP 0.022uF 50V	
* 2377	US062220	C. CE. CHP 220pF 50V		* 2538	VE021700	C. EL 2.2uF 100V	4822 124 40763
* 2378	UR896470	C. EL 4.7uF 100V		* 2539	VE021700	C. EL 2.2uF 100V	4822 124 40763
* 2382	UR896470	C. EL 4.7uF 100V		* 2540	VE021700	C. EL 2.2uF 100V	4822 124 40763
* 2383	UR896470	C. EL 4.7uF 100V		* 2541	UB045100	C. CE. M. CHP 0.1uF 50V	
* 2384	UB245220	C. CE. M. CHP 0.22uF 25V		* 2542	FX612980	C. CHP 2.2uF 16V	4822 126 14491
* 2385	UR896470	C. EL 4.7uF 100V		* 2543	US061470	C. CE. CHP 47pF 50V	
* 2395	US062220	C. CE. CHP 220pF 50V		* 2544	UR877100	C. EL 10uF 63V	
* 2402	US062220	C. CE. CHP 220pF 50V		* 2545	UR847470	C. EL 47uF 25V	
* 2404	US062220	C. CE. CHP 220pF 50V		* 3063	HX609640	R. MTL. CHP 1K 1/10W	4822 051 10102
* 2408	US062220	C. CE. CHP 220pF 50V		* 3314	HX609640	R. MTL. CHP 1K 1/10W	4822 051 10102
* 2409	US062220	C. CE. CHP 220pF 50V		* 3319	HX609640	R. MTL. CHP 1K 1/10W	4822 051 10102
* 2412	UR847470	C. EL 47uF 25V		* 3339	HX609640	R. MTL. CHP 1K 1/10W	4822 051 10102
* 2450	UB044220	C. CE. M. CHP 0.022uF 50V		* 3340	HX609640	R. MTL. CHP 1K 1/10W	4822 051 10102
* 2452	UB245220	C. CE. M. CHP 0.22uF 25V		* 3347	HX609640	R. MTL. CHP 1K 1/10W	4822 051 10102
* 2453	UR847470	C. EL 47uF 25V		* 3348	HX609640	R. MTL. CHP 1K 1/10W	4822 051 10102
* 2455	US062100	C. CE. CHP 100pF 50V		* 3363	HX609640	R. MTL. CHP 1K 1/10W	4822 051 10102
* 2456	AAX23610	C. EL 100uF 16V	4822 124 22339	* 3618	HX609640	R. MTL. CHP 1K 1/10W	4822 051 10102
* 2457	US063100	C. CE. CHP 1000pF 50V		* 3625	HX609640	R. MTL. CHP 1K 1/10W	4822 051 10102
* 2458	UB044220	C. CE. M. CHP 0.022uF 50V		* 3636	HX609130	R. MTL. CHP 100K 1/10W	4822 117 10837
* 2459	US062100	C. CE. CHP 100pF 50V		* 3637	HX609130	R. MTL. CHP 100K 1/10W	4822 117 10837
* 2460	UB044220	C. CE. M. CHP 0.022uF 50V		* 3638	HX609130	R. MTL. CHP 100K 1/10W	4822 117 10837
* 2461	US062100	C. CE. CHP 100pF 50V		* 3639	HX609130	R. MTL. CHP 100K 1/10W	4822 117 10837
* 2462	AAX23610	C. EL 100uF 16V	4822 124 22339	* 3640	HX609130	R. MTL. CHP 100K 1/10W	4822 117 10837
* 2463	US063100	C. CE. CHP 1000pF 50V		* 3641	HX609130	R. MTL. CHP 100K 1/10W	4822 117 10837
* 2464	US062100	C. CE. CHP 100pF 50V		* 3642	HX609130	R. MTL. CHP 100K 1/10W	4822 117 10837
* 2469	UB044220	C. CE. M. CHP 0.022uF 50V		* 3643	HX609130	R. MTL. CHP 100K 1/10W	4822 117 10837
* 2471	UB045100	C. CE. M. CHP 0.1uF 50V		* 3646	HX609130	R. MTL. CHP 100K 1/10W	4822 117 10837
* 2472	UR847470	C. EL 47uF 25V		* 3647	HX609130	R. MTL. CHP 100K 1/10W	4822 117 10837
* 2488	UB045100	C. CE. M. CHP 0.1uF 50V		* 3690	HX609640	R. MTL. CHP 1K 1/10W	4822 051 10102
* 2495	UB045100	C. CE. M. CHP 0.1uF 50V		* 3691	HX609640	R. MTL. CHP 1K 1/10W	4822 051 10102
* 2496	UB044220	C. CE. M. CHP 0.022uF 50V		* 3692	HX609640	R. MTL. CHP 1K 1/10W	4822 051 10102
* 2497	UR867220	C. EL 22uF 50V		* 3693	HX609640	R. MTL. CHP 1K 1/10W	4822 051 10102
* 2498	UR828100	C. EL 100uF 10V		* 3694	HX609640	R. MTL. CHP 1K 1/10W	4822 051 10102
* 2499	US062220	C. CE. CHP 220pF 50V		* 3697	HX609640	R. MTL. CHP 1K 1/10W	4822 051 10102
* 2500	US062220	C. CE. CHP 220pF 50V		* 3698	HX609640	R. MTL. CHP 1K 1/10W	4822 051 10102
* 2501	US062220	C. CE. CHP 220pF 50V		* 3699	HX609640	R. MTL. CHP 1K 1/10W	4822 051 10102
* 2502	US062220	C. CE. CHP 220pF 50V		* 3700	HX609640	R. MTL. CHP 1K 1/10W	4822 051 10102
* 2503	US062220	C. CE. CHP 220pF 50V		* 3702	HX609640	R. MTL. CHP 1K 1/10W	4822 051 10102
* 2504	US062220	C. CE. CHP 220pF 50V		* 3748	HX609130	R. MTL. CHP 100K 1/10W	4822 117 10837
* 2505	US062220	C. CE. CHP 220pF 50V		* 3749	HX609130	R. MTL. CHP 100K 1/10W	4822 117 10837
* 2506	VE021700	C. EL 2.2uF 100V	4822 124 40763	* 3750	HX609130	R. MTL. CHP 100K 1/10W	4822 117 10837
* 2507	VE021700	C. EL 2.2uF 100V	4822 124 40763	* 3751	HX609130	R. MTL. CHP 100K 1/10W	4822 117 10837
* 2508	VE021700	C. EL 2.2uF 100V	4822 124 40763	* 3752	HX609130	R. MTL. CHP 100K 1/10W	4822 117 10837
* 2509	VE021700	C. EL 2.2uF 100V	4822 124 40763	* 3753	HX609130	R. MTL. CHP 100K 1/10W	4822 117 10837
* 2511	VE021700	C. EL 2.2uF 100V	4822 124 40763	* 3754	HX609130	R. MTL. CHP 100K 1/10W	4822 117 10837
* 2519	UB045100	C. CE. M. CHP 0.1uF 50V		* 3755	HX609130	R. MTL. CHP 100K 1/10W	4822 117 10837
* 2520	US062220	C. CE. CHP 220pF 50V		* 3756	HX609130	R. MTL. CHP 100K 1/10W	4822 117 10837

* New Parts

* New Parts

P. C. B. A/V & P. C. B. DISPLAY

Schm Ref.	PART NO.	Description	Remarks
*	3757	HX609130 R.MTL. CHP 100K 1/10W	4822 117 10837
*	3758	HX609130 R.MTL. CHP 100K 1/10W	4822 117 10837
*	3759	HX609130 R.MTL. CHP 100K 1/10W	4822 117 10837
*	3760	HX609130 R.MTL. CHP 100K 1/10W	4822 117 10837
*	3761	HX609130 R.MTL. CHP 100K 1/10W	4822 117 10837
*	5400	AA222120 COIL 100uH	4822 157 70601
*	6302	AA222680 DIODE. CHP BAS216	4822 130 83757
*	6400	AA222270 CN GP1F32T	4822 130 10845
*	6401	AA222800 DIODE. CHP BZX284-C9V1	4822 130 11047
*	6403	AA222680 DIODE. CHP BAS216	4822 130 83757
*	6404	AA222810 DIODE. CHP BZX284-C5V1	4822 130 11383
*	7006	AA222740 TR. CHP BC847B	4822 130 60511
*	7007	AA222740 TR. CHP BC847B	4822 130 60511
*	7008	AA222740 TR. CHP BC847B	4822 130 60511
*	7009	AA222730 TR. CHP BC856B	4822 130 60373
*	7010	AA222740 TR. CHP BC847B	4822 130 60511
*	7011	AA222740 TR. CHP BC847B	4822 130 60511
*	7012	AA222730 TR. CHP BC856B	4822 130 60373
*	7013	AA222740 TR. CHP BC847B	4822 130 60511
*	7014	AA222740 TR. CHP BC847B	4822 130 60511
*	7300	AA222730 TR. CHP BC856B	4822 130 60373
*	7301	AA222740 TR. CHP BC847B	4822 130 60511
*	7304	AA222770 IC LF80C	9322 134 86668
*	7310	AA222740 TR. CHP BC847B	4822 130 60511
*	7329	AA222740 TR. CHP BC847B	4822 130 60511
*	7330	AA222740 TR. CHP BC847B	4822 130 60511
*	7331	AA222700 TR. CHP BC547B	4822 130 40959
*	7332	AA222730 TR. CHP BC856B	4822 130 60373
*	7333	AA222710 TR. CHP BC327-25	4822 130 41246
*	7334	AA222740 TR. CHP BC847B	4822 130 60511
*	7335	AA222740 TR. CHP BC847B	4822 130 60511
*	7400	AA21770 IC L78L33	9322 134 92676
*	7401	AA21640 IC UAD1328T	4822 209 17423
*	7402	AA222780 TR. CHP BC817-25	4822 130 42804
*	7403	AA21680 IC MC33079D	4822 209 32071
*	7404	AA222720 TR. CHP BC817-40	4822 130 42615
*	7405	AA222720 TR. CHP BC817-40	4822 130 42615
*	7406	AA222720 TR. CHP BC817-40	4822 130 42615
*	7407	AA222720 TR. CHP BC817-40	4822 130 42615
*	7900	AA21730 IC HEF4053BT	5322 209 14481
*	7901	AA21730 IC HEF4053BT	5322 209 14481
*	7902	AA21730 IC HEF4053BT	5322 209 14481
*	7903	AA21730 IC HEF4053BT	5322 209 14481
*	7904	AA21730 IC HEF4053BT	5322 209 14481
*	7905	AA21730 IC HEF4053BT	5322 209 14481
*	7917	AA21650 IC TEA6420D	4822 209 17512
*	7918	AA222740 TR. CHP BC847B	4822 130 60511
*	7919	AA222740 TR. CHP BC847B	4822 130 60511
*	7920	AA222740 TR. CHP BC847B	4822 130 60511
*	7921	AA222740 TR. CHP BC847B	4822 130 60511
*	7922	AA222740 TR. CHP BC847B	4822 130 60511
*	7923	AA222740 TR. CHP BC847B	4822 130 60511
*	7924	AA222740 TR. CHP BC847B	4822 130 60511
*	7925	AA222740 TR. CHP BC847B	4822 130 60511
*	7926	AA222740 TR. CHP BC847B	4822 130 60511
*	7927	AA222740 TR. CHP BC847B	4822 130 60511
*	7928	AA222740 TR. CHP BC847B	4822 130 60511
*	7929	AA222740 TR. CHP BC847B	4822 130 60511
*	7930	AA222740 TR. CHP BC847B	4822 130 60511
*	7931	AA222740 TR. CHP BC847B	4822 130 60511
*	7933	AA222740 TR. CHP BC847B	4822 130 60511
*	7934	AA222740 TR. CHP BC847B	4822 130 60511
*	7935	AA222740 TR. CHP BC847B	4822 130 60511

* New Parts

Schm Ref.	PART NO.	Description	Remarks
*	7936	AA222730 TR. CHP BC856B	4822 130 60373
*	7937	AA222730 TR. CHP BC856B	4822 130 60373
*	7938	AA222730 TR. CHP BC856B	4822 130 60373
*	7939	AA222730 TR. CHP BC856B	4822 130 60373
*	7941	AA222730 TR. CHP BC856B	4822 130 60373
*	7942	AA222730 TR. CHP BC856B	4822 130 60373
*	7943	AA222740 TR. CHP BC847B	4822 130 60511
*	7944	AA222740 TR. CHP BC847B	4822 130 60511
*	7945	AA222730 TR. CHP BC856B	4822 130 60373
*	7946	AA222730 TR. CHP BC856B	4822 130 60373
*	7947	AA222740 TR. CHP BC847B	4822 130 60511
*	7948	AA222730 TR. CHP BC856B	4822 130 60373
*	7949	AA222740 TR. CHP BC847B	4822 130 60511
*			
*		AA21960 P. C. B.	DISPLAY(UCART)
*		AA21970 P. C. B.	DISPLAY(GB)
*	2	AA23080 HOLDER	3139 244 00440
*	20	AA22160 CN	BMT 2P(UCRAT)
*	1100	AA22420 SW	SKQNA B
*	1101	AA22420 SW	SKQNA B
*	1102	AA22420 SW	SKQNA B
*	1106	AA22420 SW	SKQNA B
*	1107	AA22420 SW	SKQNA B
*	1108	AA22420 SW	SKQNA B
*	1109	AA22420 SW	SKQNA B
*	1110	AA223300 RSNR. CRYST	8MHz CSTS
*	1111	AA22420 SW	(GB)
*	1113	AA221510 FL. DSPLY	VFD 14-MT-27GNK
*	1115	AA22320 CN	4P
*	1117	AA22150 CN	BMV 2P M2.5(UCRAT)
*	1117	AA22320 CN	4P (GB)
*	1118	AA22340 CN	5P B5B-PH-K
*	1120	AA22400 SW	2P 100mA30V(UCRAT)
*	1205	AA22170 CN	BMH 2P M2.5(UCRAT)
*	1205	AA22330 CN	4P (GB)
*	2100	US062220 C. CE. CHP	220pF 50V(GB)
*	2101	US062220 C. CE. CHP	220pF 50V(GB)
*	2102	US062100 C. CE. CHP	100pF 50V
*	2103	US062100 C. CE. CHP	100pF 50V
*	2105	AA22460 C. CE. M. CHP	0.039uF 50V
*	2106	UR877100 C. EL	10uF 63V
*	2107	AA22460 C. CE. M. CHP	0.039uF 50V
*	2108	AA22460 C. CE. M. CHP	0.039uF 50V
*	2109	AA22460 C. CE. M. CHP	0.039uF 50V
*	2110	AA22460 C. CE. M. CHP	0.039uF 50V
*	2111	AA22460 C. CE. M. CHP	0.039uF 50V
*	2114	US061220 C. CE. CHP	22pF 50V
*	2115	US061220 C. CE. CHP	22pF 50V
*	2116	AA22460 C. CE. M. CHP	0.039uF 50V
*	2117	UR877100 C. EL	10uF 63V
*	2122	AA22460 C. CE. M. CHP	0.039uF 50V
*	2123	UR837100 C. EL	10uF 16V
*	2124	UR857220 C. EL	22uF 35V
*	2125	US061220 C. CE. CHP	22pF 50V
*	2126	UR877100 C. EL	10uF 63V
*	2128	US063100 C. CE. CHP	1000pF 50V
*	2129	UR857220 C. EL	22uF 35V
*	2130	UR857220 C. EL	22uF 35V
*	2201	AA22460 C. CE. M. CHP	0.039uF 50V
*	2211	US062100 C. CE. CHP	100pF 50V
*	6100	AA222680 DIODE. CHP BAS216	(GB) 4822 130 83757

* New Parts

EXPLODED VIEW

When disassembling, use the special screw driver with tip shape in figure.

 2.7 mm for screws with 33, 35 and 36

 1.7 mm for removing MONO board (18-2) from DVD Mechanism (18-1)

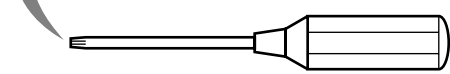

Note) The screw to fix the MONO board 18-2 to the DVD mechanism 18-1 is not available.

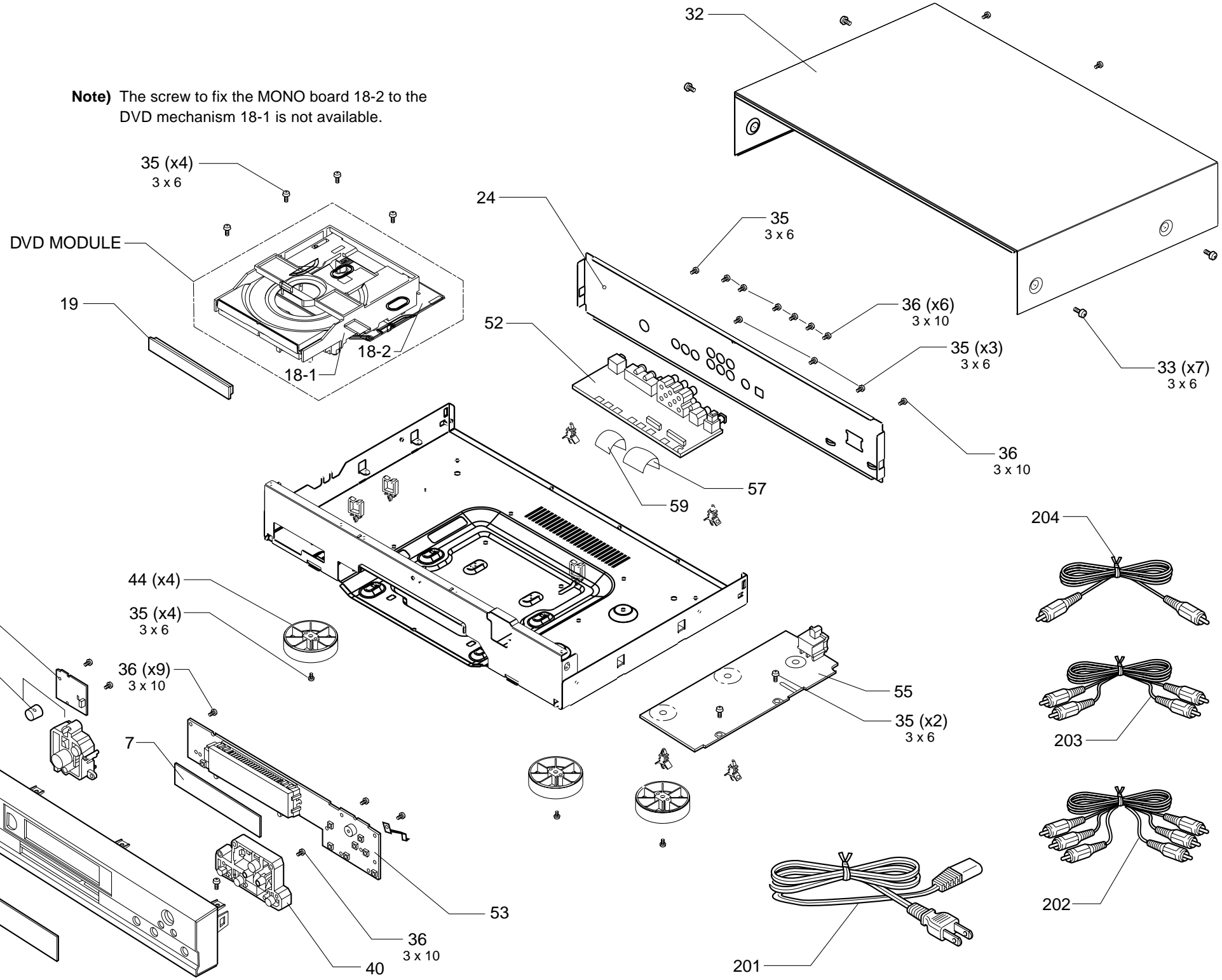
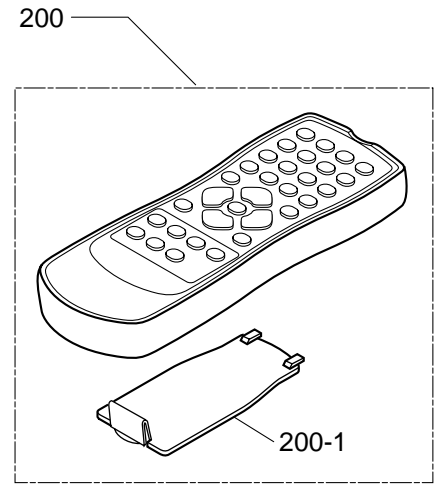







1
2
3
4
5
6
7

MECHANICAL PARTS

Ref. No.	PART NO.	Description	Remarks	Markets	
* 1	AAX23010	FRONT PANEL	S510BL	3139 247 52341	(UCA)
* 1	AAX23060	FRONT PANEL	S510GD	3139 247 52691	(RT)
* 1	AAX23050	FRONT PANEL	S5350BL	3139 247 52681	(U)
* 1	AAX23020	FRONT PANEL	S510BL	3139 247 52351	(GB)
* 1	AAX23030	FRONT PANEL	S510GD	3139 247 52361	(G)
* 1	AAX23040	FRONT PANEL	S510TI	3139 247 52371	(G)
* 2	AAX22900	BADGE YAMAHA	S510BL/TI ,S5350BL	3139 240 00061	
* 2	AAX22910	BADGE YAMAHA	S510GD	3139 240 00071	
* 4	AAX21990	WINDOW	GRAYSMOKE	3139 244 01151	
* 5	AAX22920	BUTTON/POWER	S510BL	3139 247 52381	
* 5	AAX22930	BUTTON/POWER	S510GD	3139 247 52701	
* 5	AAX22940	BUTTON/POWER	S5350BL	3139 247 52711	
* 5	AAX22430	BUTTON/STANDBY	BL	3139 247 52391	
* 5	AAX22440	BUTTON/STANDBY	GD	3139 247 52401	
* 5	AAX22450	BUTTON/STANDBY	TI	3139 247 52411	
* 7	AAX22980	FL FILTER		3139 243 10071	
		DVD MODULE	ASD-1	3104 129 21920	not available
* 18-1	AAX21470	DVD MECHANISM (BASIC ENGINE)		9305 023 61102	
* 18-2	AAX21950	P.C.B. ASS'Y	MONO BOARD	3104 128 06740	(UCART)
* 18-2	AAX21940	P.C.B. ASS'Y	MONO BOARD	3104 128 06730	(GB)
* 19	AAX23100	COVER TRAY	S510BL	3139 247 52451	
* 19	AAX23110	COVER TRAY	S510GD	3139 247 52461	
* 19	AAX23120	COVER TRAY	S510TI	3139 247 52471	
* 19	AAX23130	COVER TRAY	S5350BL	3139 247 52731	
* 24	AAX23150	REAR PANEL	S510	3139 247 52502	(UC)
* 24	AAX23160	REAR PANEL	S510	3139 247 52513	(GB)
* 24	AAX23170	REAR PANEL	S510	3139 247 52522	(R)
* 24	AAX23180	REAR PANEL	S510	3139 247 52532	(A)
* 24	AAX23200	REAR PANEL	S510	3139 247 53851	(T)
* 24	AAX23190	REAR PANEL	S5350	3139 247 52742	(U)
* 32	AAX22820	TOP COVER	BL	3139 247 50341	
* 32	AAX22830	TOP COVER	GD	3139 247 52481	
* 32	AAX22840	TOP COVER	TI	3139 247 52491	
* 33	AAX23640	PAN HEAD TORX S-TITE SCREW	3x6 ZN-BL BL	4822 502 13988	
* 33	AAX23650	PAN HEAD TORX S-TITE SCREW	3x6 NI GD, TI	2511 077 01039	
* 35	AAX23640	PAN HEAD TORX S-TITE SCREW	3x6 ZN-BL	4822 502 13988	
* 36	AAX23630	PAN HEAD TORX P-TITE SCREW	3x10 ZN-BL	4822 502 14109	
* 40	AAX23330	BUTTON/CONTROL	S510BL	3139 247 52421	
* 40	AAX23340	BUTTON/CONTROL	S510GD	3139 247 52431	
* 40	AAX23350	BUTTON/CONTROL	S510TI	3139 247 52441	
* 40	AAX23360	BUTTON/CONTROL	S5350BL	3139 247 52721	
* 44	AAX23280	FOOT ASS'Y	S510BL ,S510TI	3139 247 51261	
* 44	AAX23290	FOOT ASS'Y	S510GD	3139 247 51461	
* 44	AAX23270	FOOT ASS'Y	S5350BL	3139 247 50750	
* 52	AAX21930	P.C.B. ASS'Y	AV	3139 248 80591	(UCART)
* 52	AAX21920	P.C.B. ASS'Y	AV	3104 128 06121	(GB)
* 53	AAX21960	P.C.B. ASS'Y	DISPLAY	3139 248 80221	(UCART)
* 53	AAX21970	P.C.B. ASS'Y	DISPLAY	3139 248 80361	(GB)
* 55	AAX23430	POWER SUPPLY UNIT	120V	3139 248 80381	(UC)
* 55	AAX23440	POWER SUPPLY UNIT	110-240V	3139 248 80391	(ART)
* 55	AAX23420	POWER SUPPLY UNIT	20PS223 230V	3122 427 22301	(GB)
* 57	AAX22990	FLEXIBLE FOIL CONNECTION	FFC 22P 130mm	3139 110 34220	
* 59	AAX23000	FLEXIBLE FOIL CONNECTION	FFC 16P 130mm	3139 110 34230	

* New Parts

DVD-S510/DV-S5350

Ref. No.	PART NO.	Description	Remarks	Markets
		ACCESSORY		
* 200	AAX23140	REMOTE CONTROL TRANSMITTER	RC1113202/00	3139 228 87081
* 200-1	AAX23890	LID		3139 224 22450
*  201	AAX23370	POWER CORD ASS'Y	1.8m 1pc	2422 070 98109 (UC)
*  201	AAX23410	POWER CORD ASS'Y	1.8m 1pc	3139 118 73042 (A)
*  201	AAX23400	POWER CORD ASS'Y	1.8m 1pc	3139 118 72784 (R)
*  201	AAX23660	POWER CORD ASS'Y	1.8m 1pc	4822 321 10249 (T)
*  201	AAX23390	POWER CORD ASS'Y	1.8m 1pc	3111 170 21831 (G)
*  201	AAX23380	POWER CORD ASS'Y	1.8m 1pc	3103 140 26741 (B)
* 202	AAX23450	AUDIO/VIDEO CORD	YE/RD/WH 1.5m 1pc	2422 076 00304 (UCART)
* 203	AAX21980	AUDIO CORD	RD/WH 1.5m 1pc	3103 308 92611 (GB)
* 204	AAX22970	VIDEO CORD	YE 1.5m 1pc	3104 108 45432 (GB)

■ DVD MECHANISM ASS'Y

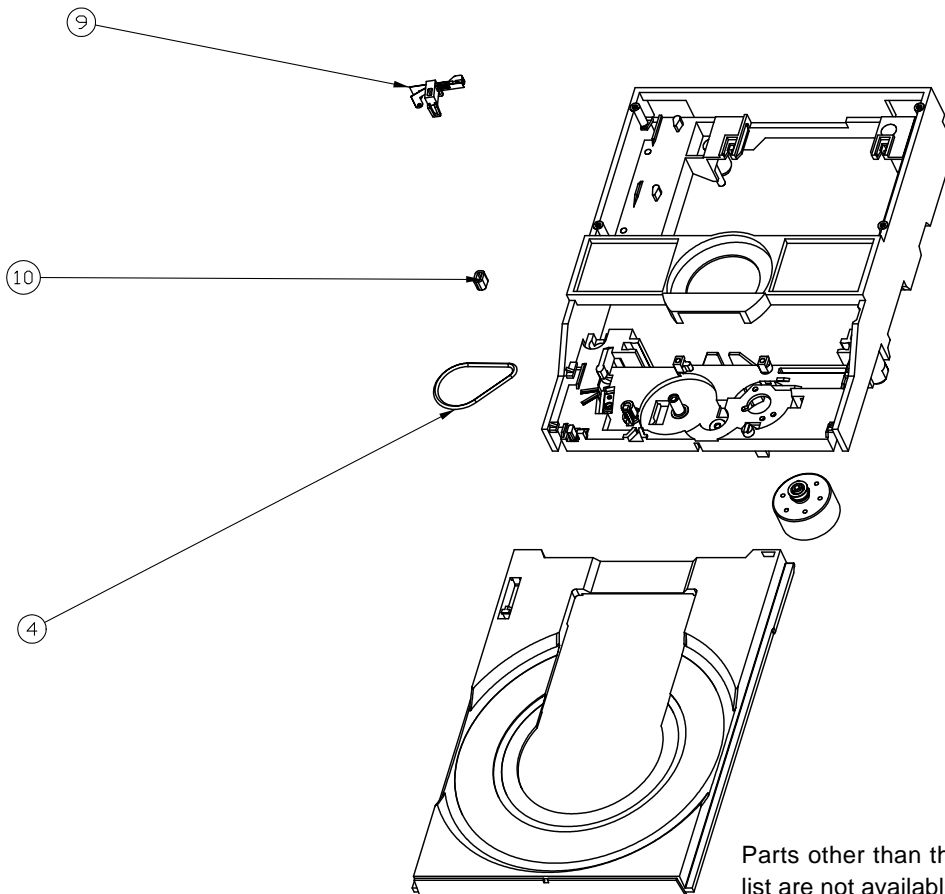

Parts other than the following parts list are not available as spare parts.

Ref. No.	PART NO.	Description	Remarks	Markets
* 4	AAX21470	DVD MECHANISM (BASIC ENGINE)	9305 023 61102	
* 4	AAX23070	BELT/DRIVING	4822 358 10266	
* 9	AAX22410	SWITCH/OTHERS	3139 198 80010	
* 10	AAX23210	RING	TULE 4822 532 13097	
* 4		TRAY	3139 194 00270	not available
* 4		MOTOR	DC <=37.5W 3139 197 50060	not available

* New Parts